

# *Apple III*

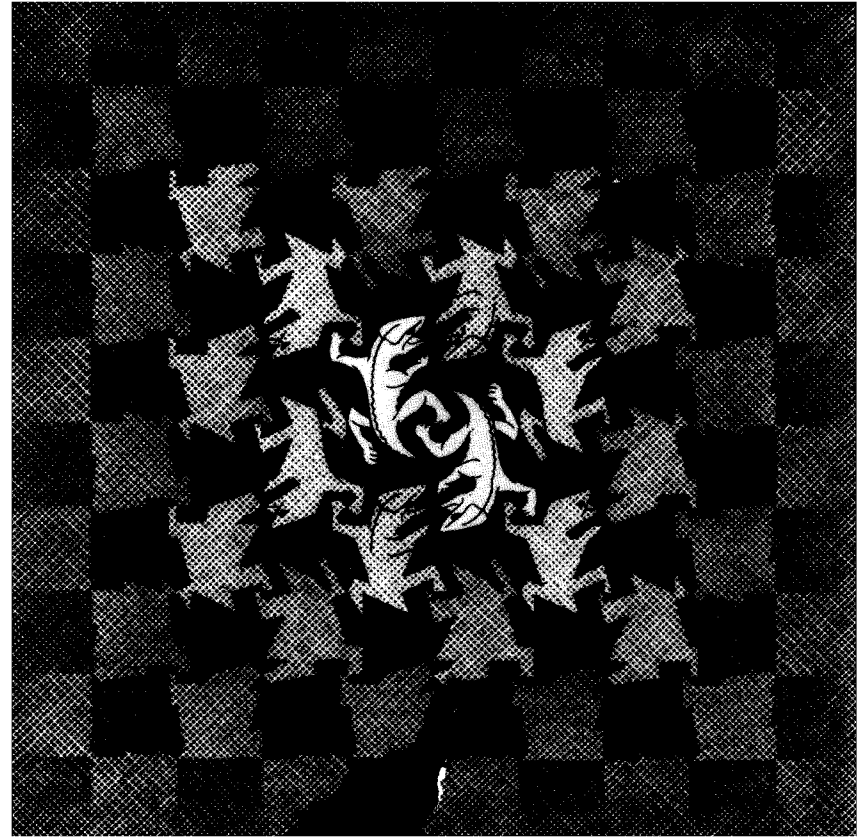

## **Notice**

Apple Computer reserves the right to make improvements in the product described in this manual at any time and without notice.

## **Disclaimer of All Warranties And Liabilities**

Apple Computer makes no warranties, either express or implied, with respect to this manual or with respect to the software described in this manual, its quality, performance, merchantability, or fitness for any particular purpose. Apple Computer software is sold or licensed "as is." The entire risk as to its quality and performance is with the buyer. Should the programs prove defective following their purchase, the buyer (and not Apple Computer, its distributor, or its retailer) assumes the entire cost of all necessary servicing, repair, or correction and any incidental or consequential damages. In no event will Apple Computer be liable for direct, indirect, incidental, or consequential damages resulting from any defect in the software, even if Apple Computer has been advised of the possibility of such damages. Some states do not allow the exclusion or limitation of implied warranties or liability for incidental or consequential damages, so the above limitation or exclusion may not apply to you.

This manual is copyrighted. All rights are reserved. This document may not, in whole or part, be copied, photocopied, reproduced, translated or reduced to any electronic medium or machine readable form without prior consent, in writing, from Apple Computer.

© 1981 by Apple Computer  
10260 Bandley Drive  
Cupertino, California 95014  
(408) 996-1010

Written by David Cásseres

The word Apple and the Apple logo are registered trademarks of Apple Computer.

Reorder Apple Product #A3L0003

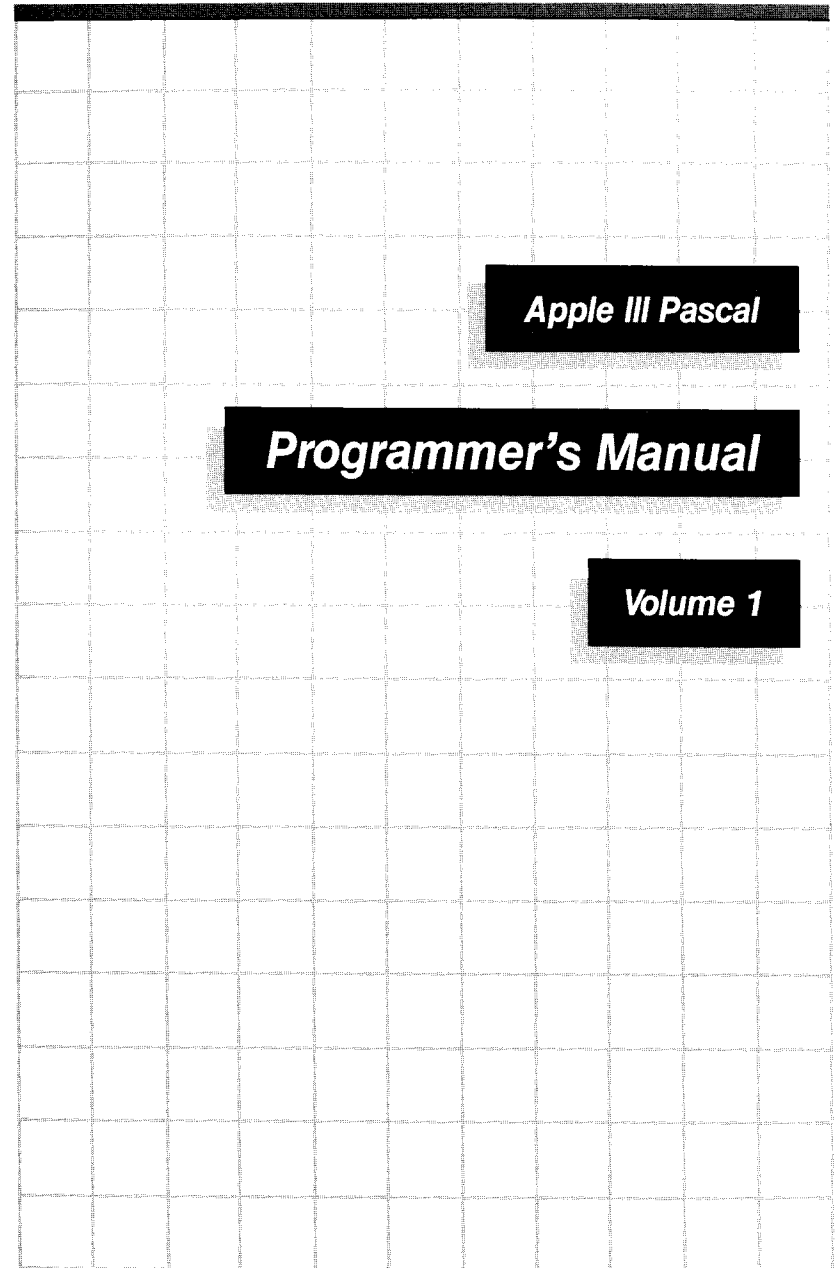

## Acknowledgements

The Apple III Pascal system is based on UCSD Pascal. "UCSD PASCAL" is a trademark of the Regents of the University of California. Use thereof in conjunction with any goods or services is authorized by specific license only and is an indication that the associated product or service has met quality assurance standards prescribed by the University. Any unauthorized use thereof is contrary to the laws of the State of California.

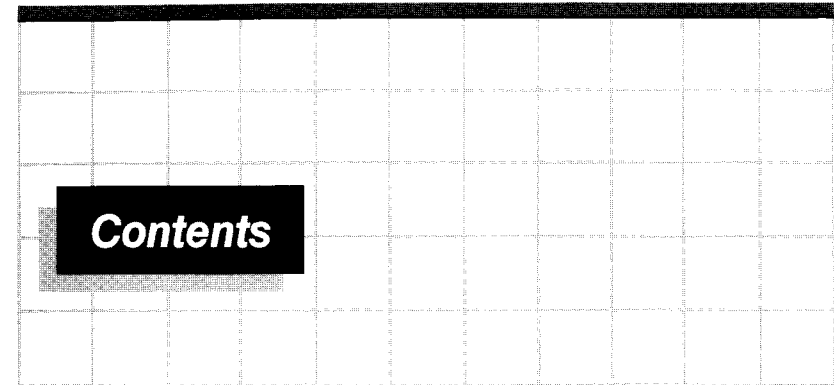

## Volume I—Chapters

### **Preface** *xiii*

---

### **1** **What is Apple III Pascal?** **1**

---

- 2 Introduction
- 3 Pascal vs. BASIC
- 4 Pascal vs. FORTRAN
- 5 Structure of a Pascal Program
- 5 A Sample Program

### **2** **Overview of Pascal** **7**

---

- 8 Pascal Source Text
- 9 Symbols
- 12 Declarations
- 13 Data Types
- 18 Statements
- 22 Expressions
- 24 Procedures
- 25 Functions
- 26 Built-In Procedures and Functions
- 26 Pascal Program Structure
- 30 Sample Program

---

### **3 Simple Data Types** 33

- 34 Introduction
- 35 Declarations
- 38 The Real Type
- 40 Scalar Types
- 40 The Integer Type
- 42 The Long Integer Type
- 43 The Char Type
- 45 The Boolean Type
- 45 Defining New Scalar Types
- 46 Subrange Types
- 47 Built-In Functions For Scalar Types
- 49 Numeric Functions

### **4 Expressions and Assignments** 51

- 52 Introduction
- 53 Precedence of Operators
- 56 The Arithmetic Operators
- 60 The Relational Operators
- 62 Logical Operators
- 63 Relational Operators with Boolean Operands
- 63 Result Types
- 64 Assignments

### **5 The Flow of Control** 65

- 66 Introduction
- 67 The Compound Statement
- 68 The Procedure Call
- 69 The Repetition Statements
- 73 The Conditional Statements
- 80 The EXIT and HALT Procedures
- 81 The GOTO Statement

---

### **6 Procedures and Functions** 83

- 84 Introduction
- 85 Defining a Procedure
- 87 Value Parameters
- 89 Variable Parameters
- 90 Defining a Function
- 92 Calling a Function
- 92 Recursion
- 96 Rules of Scope
- 99 Segment Procedures and Functions
- 100 External Procedures and Functions
- 101 Size and Complexity Limits

### **7 Arrays, Sets, and Strings** 103

- 104 Introduction
- 104 Array Variables
- 115 Sets
- 120 Strings
- 124 String Built-Ins

### **8 Records** 129

- 130 Record Variables
- 135 The WITH Statement
- 138 Comparisons and Assignments
- 139 Packed Records

### **9 Pointers and Dynamic Variables** 141

- 142 Concepts
- 144 Pointer Values
- 144 Declaring Pointer Variables
- 145 Using Pointers
- 147 The NEW Procedure
- 150 MEMAVAIL
- 151 MARK and RELEASE

---

<b>10</b>	<b><i>Introduction To Files and I/O</i></b>	<b>155</b>
	156 Files	
	161 Overview of Apple III Pascal I/O Facilities	
	162 Typed File I/O	
	175 Random Access	
	178 Special Handling of Control Characters With GET and PUT	
<b>11</b>	<b><i>Text I/O</i></b>	<b>181</b>
	182 Introduction	
	182 Character Files	
	184 Using the Procedures and Functions	
	185 The EOLN Function	
	186 The READ Procedure	
	190 The READLN Procedure	
	191 The WRITE Procedure	
	194 The Writeln Procedure	
	197 The PAGE Procedure	
	197 Additional Details	
<b>12</b>	<b><i>Block File I/O and Device I/O</i></b>	<b>201</b>
	202 Introduction	
	202 Block File I/O	
	206 Device I/O	
	213 Textfiles and Asciifiles	
<b>13</b>	<b><i>Special-Purpose Built-Ins</i></b>	<b>217</b>
	218 Introduction	
	218 Byte-Oriented Features	
	224 Miscellaneous Procedures	

---

<b>14</b>	<b><i>Library Units</i></b>	<b>231</b>
	232 Introduction	
	233 Regular Units	
	234 Intrinsic Units	
	236 Writing a Unit	
	243 An Example Unit	
	245 Using the Example Unit	
	246 Nesting Units	
	250 Program Libraries and SYSTEM.LIBRARY	
	250 Changing a Unit or its Host Program	
<b>15</b>	<b><i>Program Segmentation</i></b>	<b>253</b>
	254 Program Segments	
	255 The Segment Dictionary	
	255 The Run-Time Segment Table	
	258 Loading of Segment Procedures and Functions	
	259 Loading of Unit Segments	
	261 The RESIDENT Option	
	<b><i>Figures and Tables</i></b>	<b>265</b>
	<b><i>Index</i></b>	<b>273</b>

## Volume II—Appendices

---

	<b><i>Preface</i></b>	<b>ix</b>
<b>A</b>	<b><i>The TRANSCEND and REALMODES Units</i></b>	<b>1</b>
	2 Introduction	
	2 The Units	
	4 The Functions	
	5 The Remainder (REM) Function	

---

## **B** *The PGRAF Unit* 11

---

- 13 Overview
- 18 Memory Usage
- 19 Saving and Loading Display Buffers
- 19 Summary of PGRAF Routines
- 20 Initial Conditions
- 20 GRAPHIXMODE
- 21 GRAPHIXON and TFXTON
- 21 PENCOLOR and FILLCOLOR
- 22 VIEWPORT
- 23 INITGRAFIX
- 23 MOVETO, LINETO, and DOTAT
- 24 MOVEREL, LINEREL, and DOTREL
- 24 FILLPORT
- 25 XYCOLOR, XLOC, and YLOC
- 25 Text in Graphics
- 26 DRAWIMAGE
- 29 The Color Table
- 31 The Transfer Option
- 33 NEWFONT and SYSFONT
- 34 GSAVE and GLOAD
- 35 The CP280 Mode
- 36 Reading From the Graphics Driver
- 37 The PGRAF Interface

## **C** *The CHAINSTUFF Unit* 39

---

- 40 The SETCHAIN Procedure
- 41 The SETCVAL Procedure
- 41 The GETCVAL Procedure
- 42 An Example of Chaining

## **D** *The APPLESTUFF Unit* 45

---

- 46 The RANDOM Function
- 48 The RANDOMIZE Procedure
- 48 The KEYPRESS Function
- 49 The JOYSTICK Procedure
- 49 The SOUND Procedure
- 50 The Internal Date and Time
- 52 PADDLE, BUTTON, and NOTE

---

## **E** *Floating-Point Arithmetic* 55

---

- 56 Introduction
- 59 Exceptions
- 62 Floating-Point Format
- 64 Arithmetic with Denormalized Numbers
- 65 Infinity Arithmetic and Comparisons
- 69 NaNs
- 71 Accuracy
- 76 Real Arithmetic Environments
- 77 Exception Handling
- 78 Arithmetic Modes
- 83 Summary of the Floating-Point System
- 85 Bibliography

## **F** *The Apple III Pascal Compiler* 87

---

- 88 Introduction
- 88 Diskette Files Needed
- 89 Using the Compiler
- 93 Compiler Option Syntax
- 94 Options that Do Not Affect Program Code
- 98 Error Checking Options
- 100 Control of Segments and Libraries
- 102 The USING Option
- 102 The INCLUDE Option
- 103 Special Compilation Mode
- 104 Conditional Compilation
- 109 Compiling Apple II Code
- 110 Compiler Option Summary

## **G** *Special Techniques* 113

---

- 114 Introduction
- 114 Representation of Scalar Values
- 116 Implications
- 119 Representation of Arrays
- 120 Representation of Real Values
- 120 Free Union Variants
- 124 Byte-Oriented Built-Ins Revisited
- 125 Special Uses of UNITSTATUS

---

## **H** *Comparison To Apple II Pascal* 127

128	OTHERWISE Clause in CASE Statement
128	SOS Pathnames
128	SOS Device Driver Support
128	Graphics
129	New Procedures
129	New Data Types
129	Real Arithmetic
129	Library Files and Units
130	Memory Organization
130	The UNITSTATUS Procedure
130	Runtime Segment Table
130	Conditional Compilation
131	The CHAINSTUFF Unit
131	Compiling Apple II Code
131	File Variable Size
131	Compiler Options
131	Procedure Complexity
131	System Globals

## **I** *Syntax Diagrams* 133

134	Compilation
134	Program
135	Unit
135	Intrinsic Unit heading
135	Regular Unit heading
136	Interface
136	Implementation
137	Block
137	Uses Declarations
138	Label Declarations
138	Constant Declarations
138	Constant
138	Type Declarations
139	Type
139	Simple Type
139	User-defined Scalar Type
140	Subrange Type
140	Pointer Type
140	Set Type
140	String Type
140	Array Type
141	Record Type

141	Field List
141	Variant Part
142	File Type
142	Variable Declarations
142	Procedure Definition
143	Function Definition
143	Parameter List
143	Parameter Declaration
143	Compound Statement
144	Statement
144	Assignment Statement
144	Procedure Call
145	With Statement
145	Goto Statement
145	For Statement
145	Repeat Statement
146	While Statement
146	If Statement
146	Case Statement
146	Case Clause
147	Otherwise Clause
147	Expression
147	Simple Expression
148	Term
148	Factor
149	Variable reference
149	Function Call
149	Set Constructor
150	Unsigned Constant
150	Unsigned Number
150	Unsigned Integer
151	Identifier

## **J** *Tables* 153

154	Table 1: Execution Errors
155	Table 2: I/O Errors
157	Table 3: Reserved Words
158	Table 4: Predefined Identifiers
159	Table 5: Compiler Error Messages
164	Table 6: ASCII Character Codes
165	Table 7: Standard I/O Devices
166	Table 8: Size Limitations

<b>K</b>	<b><i>The TURTLEGRAPHICS Unit</i></b>	<b>167</b>
	168 Using Apple II TURTLEGRAPHICS with the Apple III	
	<b><i>Figures and Tables</i></b>	<b>169</b>
	<b><i>Index</i></b>	<b>177</b>

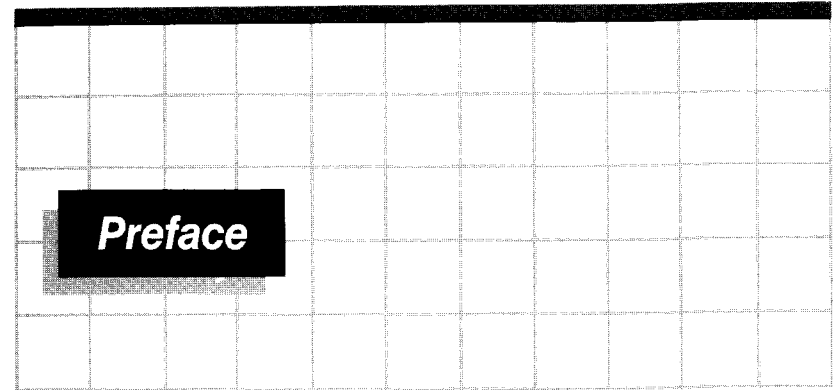

The Apple III Pascal system is described in three manuals:

Apple III Pascal: Introduction, Filer, and Editor  
 Apple III Pascal Program Preparation Tools  
 Apple III Pascal Programmer's Manual (Volumes 1 and 2)

Before using the Apple III Pascal system or reading its manuals, you should be familiar with starting up the Apple III as described in the Apple III Owner's Guide.

When you are familiar with the contents of that manual, begin reading the Apple III Pascal: Introduction, Filer, and Editor manual. The Filer and the Editor described in this manual are needed by everyone who uses the Pascal system. If you are familiar with the Apple II Pascal system, this manual will show you the differences in operation between the two systems.

Apple III Pascal Program Preparation Tools is the next manual that you should read before you start to develop Pascal and assembly-language programs to run on the Apple III. The components of the Apple III Pascal system covered in this manual include

- The Linker, used to combine separately developed program segments stored in libraries with your application program.
- The Apple III Pascal 6502 Assembler, used to translate assembly-language source files produced by the Pascal Editor into machine-language code files.
- The Librarian, used to put commonly used routines into libraries for use with application programs.



Your main source of information while developing Pascal programs will be the two volumes of the Apple III Pascal Programmer's Manual, which contain a complete description of the Pascal language on the Apple III and the use of the Apple III Pascal Compiler.

## The Contents of This Manual

This manual describes the complete Apple III Pascal language. Except for the introductory material in Chapters 1 and 2, this is an explanatory reference manual rather than a textbook; it does not assume that you know anything about Pascal, but it does assume that you are familiar with computer programming in some language.

Please note that a large and detailed index is provided at the end of this manual; you will probably need it when you are using the manual for reference purposes. The index does not point to every occurrence of a word or phrase in the manual; instead it points to the pages that have significant information about the topic associated with the word or phrase.

Volume 1 of this manual contains the chapters; Volume 2 contains the appendices and the index. Here is a brief description of the contents:

- Chapter 1 is an introduction to the Pascal language, comparing it with other well-known languages and giving a very simple program as an example.
- Chapter 2 is an extensive overview of Pascal. Every major concept and construction in the language is introduced here at an intuitive level.
- Chapters 3 through 11 provide complete, detailed information about every major feature of the language.
- Chapters 12 through 15 provide complete, detailed information about the more specialized features of the language. These features are needed for certain large or specialized programs.
- Appendices A through E describe the standard library facilities of Apple III Pascal. These are sets of procedures and functions for special purposes such as graphics, audio, joystick inputs, and special arithmetic features.

- Appendix F is a complete reference manual for the Apple III Pascal Compiler, including details of operation and all of the Compiler options.
- Appendices G through J are supplementary information on various topics. In particular, Appendix J is a collection of useful tables.
- Appendix K provides information on the use of Apple II TURTLEGRAPHICS on the Apple III.

Two special symbols are used throughout this manual to draw your attention to particular items of information.



The pointing hand indicates something particularly interesting or useful.



The eye is used for points you need to be cautious about.

## Syntax Diagrams

Throughout this manual, the syntax of the Pascal language is indicated by means of syntax diagrams, also known as "railroad tracks." These diagrams are easy to follow once you are used to them: begin at the upper left and follow the arrows. Every possible path through the diagram represents a valid construction in Pascal. For example:

### while statement

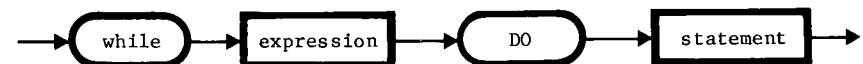

This diagram tells us that a "while statement" consists of the word WHILE, followed by an expression, followed by the word DO, followed by a statement.

The words WHILE and DO are enclosed in rounded "bubbles;" this means that they are reserved words or symbols of the language, to be typed as shown. The words expression and statement are in boxes with square corners; this means that they are higher-level constructions, which have their own syntax diagrams.

Here is an example where there is more than one path through the diagram:

identifier

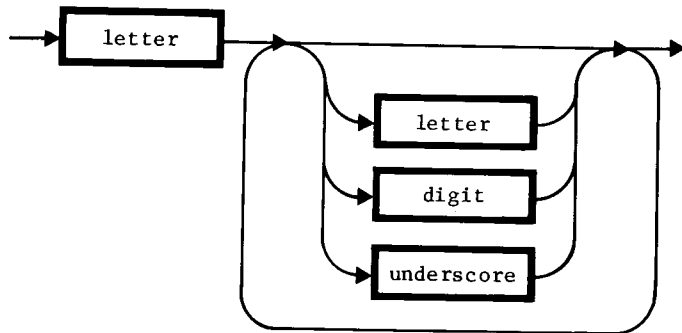

This tells us that an identifier begins with a letter, and this letter may be followed by a letter, a digit, an underscore, or nothing. From here, there is the possibility of looping back to add another letter, digit, underscore, or nothing. This can be repeated indefinitely (in principle), so the syntax says that an identifier can be of any length. In practice, of course, there is a limit which the syntax does not show.



Note that Appendix I contains a full set of syntax diagrams.

### *Syntax of Procedure and Function Calls*

Pascal provides a number of built-in procedures and functions which are activated by means of "calls." Most of these use a simple kind of syntax in which there is only one path through the diagram, and in these cases a diagram is not shown. Instead, a "form" is given; for example, the form of the REWRITE procedure is

```
REWRITE ( FILEID, PATHNAME )
```

The word REWRITE is the name of the procedure, and is to be typed as shown; all words in parentheses are names for "parameters," to be replaced with actual expressions or variable identifiers as explained in the text. In this example, FILEID is to be replaced by the identifier of a "file variable" and PATHNAME is to be replaced by a string of characters that is the pathname of a file.

A few procedures have a more complex form of syntax, and syntax diagrams are used for these.

---

**1**

***What is Apple III Pascal?***



---

## Introduction

---

Apple III Pascal is an implementation of the Pascal language for the Apple III computer. It is based on UCSD Pascal, which in turn is based on the original definition of Pascal by Kathleen Jensen and Niklaus Wirth in the Pascal User Manual and Report (Springer-Verlag, 1974). Chapter 2 is a comprehensive overview of the language. This chapter is a brief description to give the flavor of Pascal, especially in comparison to two other popular general-purpose languages, BASIC and FORTRAN.

Pascal is a modern high-level programming language that belongs to the family of Algol-like languages; that is, it is descended from the Algol language which introduced many of the fundamental ideas of modern high-level programming. Like Algol, Pascal is written free-form and is block-structured. It goes beyond Algol in several ways; the most important is that Pascal has a great variety of different data types and allows the programmer to define new data types.

An Apple III Pascal program is first written as a text file, using the system's Editor; this text is called the source of the program. Next it is compiled by the Pascal Compiler. The Compiler produces a file of P-code, a special code that resembles machine language.

The P-code can then be "executed" by an interpreter program, which interprets the P-code instructions and executes them immediately. The interpreter program is known as the P-machine, and is an integral part of the software system. The use of P-code and an interpreter provides an important benefit: with a few limitations, the P-code of an Apple III Pascal program can also be executed by a different P-machine on a different computer.

An important part of the philosophy of high-level languages is to separate the programmer from the details of the computer hardware. In Pascal, for instance, there is no need to refer to specific physical addresses in memory. The system takes care of all memory management, without any intervention from the Pascal program. The system also provides control of all special machine features via Pascal statements; in most cases, this eliminates the need for writing machine-language routines for detailed

---

control of the hardware. However, there is a way to link machine-language routines into a Pascal program.

## Pascal vs. BASIC

---

If you are a BASIC programmer, you will find that Pascal is different in some very fundamental ways:

- LINE NUMBERS: Pascal has no line numbers. In fact, line breaks mean nothing in a Pascal program. You can break up a statement into several lines or put several statements on one line. Statements are separated from each other by semicolons. You will find that the mechanics of writing, editing, or modifying a Pascal program are easier than with BASIC because you don't need to maintain line numbers.
- VARIABLES: All variables in a Pascal program must be declared before they can be used. A variable declaration associates an identifier (variable name) with one of the many data types of Pascal. (In BASIC, only arrays need to be declared, via the DIM statement.)
- FLOW OF CONTROL: Pascal has several methods for controlling the sequence in which statements are processed. These methods go beyond the IF, FOR, GOTO, and GOSUB/RETURN of BASIC. As a result, most Pascal programs are easier to read and understand than comparable BASIC programs. Pascal has a GOTO statement, but it is much less important than the other methods.
- PROCEDURES: In Pascal you can write a procedure, which is simply a subprogram. The main program can execute the subprogram by mentioning its name. This replaces the GOSUB/RETURN mechanism of BASIC and is more powerful, since the main program can supply parameter values to the procedure when it executes it.
- FUNCTIONS: A Pascal function is just a procedure that returns a value, in the same way as a BASIC user-defined function. A Pascal function definition can contain any number of statements, where a BASIC

---

user-defined function is usually severely limited in the number of statements it can contain.

- BLOCK STRUCTURE: Block structure means that a procedure or function can have its own variables which are independent of the main program. A procedure or function can even have a variable of its own which has the same name as a variable in the main program. Because of this, a Pascal programmer can use a kind of discipline that is not possible in BASIC; the result is cleaner, more comprehensible programs.
- PHYSICAL ADDRESSES: There are no POKE, PEEK, or CALL statements in Pascal. A Pascal program doesn't use physical addresses; various mechanisms in Pascal make them unnecessary.

## ***Pascal vs. FORTRAN***

---

If you are a FORTRAN programmer, these differences will be particularly noticeable:

- There are no line numbers.
- Identifiers (names) are less restricted.
- The format of the program text is less restricted.
- The program control structures are more constrained.
- Procedures and functions can be recursive: that is, they can call themselves either directly or indirectly.
- Block structure (see above) allows better program organization and eliminates the need for common blocks. Subprograms (procedures and functions) are written within the main program, and automatically have access to the main program's data.
- There is no equivalencing of variables.
- Variables can be created dynamically as the program runs, and referenced through pointers.

- 
- There is no implicit typing. The type of every variable is explicitly declared.
  - There are no OWN (SAVE) variables.
  - I/O formatting facilities are simpler.

## ***Structure of a Pascal Program***

---

Every Pascal program has the following outline (words in capital letters are "reserved words" of Pascal):

```

program heading,
    containing the word PROGRAM and the program's name;

declarations of any user-defined data types,
variables, etc.

definitions of any procedures and functions

the word BEGIN

    any number of statements, separated by semicolons

the word END, followed by a period
  
```

## ***A Sample Program***

---

Here is a very simple Pascal program, which displays 11 lines of text on the screen. Each line displayed contains a different number, counting from 0 to 10. The program is presented here without explanation, just to show you what Pascal source text looks like. The words between starred parentheses are Pascal-language comments. At the end of the next chapter, we will see this program again with an explanation.

```
PROGRAM FIRSTEXAMPLE;           { program heading }
VAR I:INTEGER;                  { declaration of
                                a variable }
PROCEDURE DISPLAY (J:INTEGER);  { procedure definition }
BEGIN
  WRITELN;
  WRITELN('The number is ', J)
END;                             { end procedure
                                definition }

BEGIN                           { begin program body }
  FOR I:=0 TO 10 DO DISPLAY(I)   { statement }
END.                             { end of program }
```

The output from this program appears on the screen as follows:

```
The number is 0
The number is 1
The number is 2
The number is 3
The number is 4
The number is 5
The number is 6
The number is 7
The number is 8
The number is 9
The number is 10
```



2

## Overview of Pascal

This chapter gives a brief account of each major feature of Apple III Pascal, and tells you where to find further information in this manual.

## **Pascal Source Text**

The source text of a Pascal program is a sequence of symbols. Symbols are like the words, spaces, and punctuation marks that make up a paragraph of English sentences. The kinds of symbols that make up Pascal programs are

- Reserved words (the fixed vocabulary of Pascal)
- Identifiers (names: some made up by the programmer, and others built into the language)
- Numeric constants (numbers written in the program to be used as data)
- Character and string constants (characters written in the program to be used as data)
- Delimiters (special characters and punctuation)

These different kinds of symbols are described further under "Elements of the Language" below.

A Pascal program can also contain comments. A comment is text that is totally ignored by the Compiler; it serves to make the program more comprehensible to a human reader. Anything enclosed within the special symbols { and } is a comment; also, anything enclosed within the special symbols (\* and \*) is a comment. For example:

```
{This is a comment}
(*This is another comment*)
```

A comment formed with the {} delimiters can include the (\* \*) delimiters, and vice versa.

The source text of a Pascal program is written free-form: that is, you can break the text into lines in any way you like, you can indent the lines in any way you like, and you can insert spaces freely between symbols. For example, the Pascal statement

```
FOR I:= 0 TO N DO BEGIN A:=I; B:=2*I+1 END
```

can also be written as follows:

```
FOR I := 0 TO N DO BEGIN
    A := I;
    B := 2*I + 1
END
```

or in many other ways. All that matters is the sequence of symbols. It is customary to break the text into lines which are meaningful, and to use indentation (as above) to improve clarity. There are no specific rules for this; as you learn the language you will understand the way indentation is used in the examples and develop your own style.

Another way to write our sample Pascal statement is

```
For i := 0 to n do Begin a:=i; b:=2*i + 1 End
```

In this manual, most Pascal program text is shown in capitals, simply to set it off from other text. However, the capitalization of letters is not significant in Pascal (except within constants, as we will see).

## **Symbols**

Symbols are the smallest meaningful elements in Pascal, corresponding to the words, spaces, and punctuation in an English sentence. Everything else in the language is built up out of symbols.

### **Reserved Words**

These symbols are words such as FOR, WHILE, AND, DO, and BEGIN. They make up the essential vocabulary of Pascal and have fixed meanings. A complete table of reserved words is given in Appendix J.

### **Identifiers**

These symbols are names for things such as variables, data types, and procedures. Most identifiers are made up by the programmer

and given meanings in declarations; other identifiers are names of variables, data types, procedures, etc., that are built into the language and don't need to be declared. The syntax for an identifier is

identifier

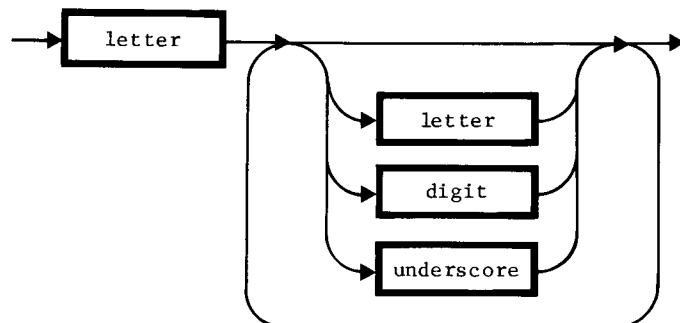

Thus an identifier must begin with a letter, and this letter may be followed by any number of letters, digits, or underscores. The Compiler ignores the case of letters; 'A' and 'a' are equivalent. Underscore characters in an identifier are ignored; their only purpose is to make an identifier more legible. Also, only the first eight characters (not counting underscores) are significant. For example, the following six identifiers are equivalent and interchangeable:

MYNUMBER	mynumber
MY_NUMBER	My_Number
MY_NUMBER_VALUE	MY_NUMBER_SYMBOL

There is an important restriction on identifiers: an identifier must not be the same as any reserved word.

## Numeric Constants

Numeric constants are signed decimal integer or floating-point values that are written into the program to be treated as data. In Pascal there are two kinds of numeric data called integer and real. Integer constants must fall in the range -32767 to 32767. The following are valid integer constants:

```
-1 2 865 16383 -2000 0 1949
```

A real constant contains a decimal point (period) and may contain an "exponent part." The exponent part consists of the letter "E" and a number, and indicates multiplication by a power of ten. The following are valid real constants, and all represent the same numerical value:

```
3.14159 0.314159E1 3141.59E-3
```

## Character Constants

These are single characters written into the program to be treated as data. The apostrophe or "single quote" is used to set off character constants. The following are examples:

```
'a' 'A' '0' '+' ''''
```

The first two constants, 'a' and 'A', are not equivalent. Capital letters are distinguished from lower case in constants. The last example shows how to represent a single quote as a character constant. By the way, don't confuse two single quotes with the double-quote character ("), which has no meaning in Pascal.

## String Constants

These are character sequences written into the program to be treated as data. Like character constants, they are set off by apostrophes. Examples:

```
'Smith' '$408.23' 'Type your name: ' 'DON'T WORRY' ''
```

Capital letters are distinguished from lower case. The next-to-last example shows how to use an apostrophe as a character within a string constant. The last example shows how to represent a string consisting of no characters.

## Delimiters

Delimiters have the effect of separating other symbols from each other, which is why they are called delimiters. When two symbols are not separated by a delimiter, they must be separated by a space or a line break.

These special characters (and a few two-character combinations) also have various special meanings such as arithmetic operations, array indexing, setting off comments, etc. The one-character



delimiters are

```
, . ; : ' ( ) [ ] + - / * = < > ^ { }
```

and the two-character delimiters are

```
:= .. (* *) <= >= <>
```

## Declarations

You can think of a Pascal program as being made up of two kinds of "sentences"--statements, which generally cause some kind of action to occur when the program is executed, and declarations. Use declarations to announce the nature of an identifier.

### Variable Declarations

All variables must be declared (except dynamic variables, which are discussed later). The effect of a variable declaration is to create an identifier, associate it with a data type, and allocate memory space for it. Variable declarations are introduced by the reserved word VAR. Example:

```
VAR NEWVALUE:INTEGER;
    RESULT:REAL;
```

These two declarations create an identifier NEWVALUE which is the name of an integer variable, and an identifier RESULT which is the name of a real variable.

### Constant Declarations

Identifiers may also be declared for numeric and character constants. A constant identifier can then be used in the program instead of the constant itself. Constant declarations are introduced by the reserved word CONST. Example:

```
CONST PI=3.14159;
      ROWSIZE=64;
      COLUMNSIZE=2048;
```

These three declarations create the identifiers PI, ROWSIZE, and COLUMNSIZE, with the values indicated. In a program that uses the value of pi in many different statements, it is more

convenient to declare PI as shown and use it in the statements instead of having to write 3.14159 repeatedly. Another advantage of declared constants is that if a program is first developed with ROWSIZE and COLUMNSIZE as shown above, and later you want to change these values, you need only change the declarations rather than searching through all the statements for the values 64 and 2048.

### Type Declarations

Pascal allows you to declare your own data types, as described in the next section. Type declarations are introduced by the reserved word TYPE.

## Data Types

Pascal has a great variety of data types. They are described very briefly here, and several chapters are devoted to describing them in detail. The data types are broken into two broad categories called "simple" and "structured" types; a simple data type represents just one value, while a structured type represents a collection of values.

Most of the simple types are "scalar" types. This important term is defined in Chapter 3.

### The Real Type

Real values are signed, 32-bit floating-point numbers in the proposed IEEE format with a precision of about seven decimal places (depending on the actual value). The range of real values is from plus or minus 1.401298464E-45 to plus or minus 3.402823466E38; also, 0.0 is a real value. (See Appendix E for complete details.)

### The Integer Type

Integer values are signed whole numbers in the range -32768 to 32767. There are also "long integers" which are BCD-coded and can represent values up to 36 decimal digits.

## The Char Type

A value of type char is a character: that is, any member of the extended 8-bit ASCII character set used on the Apple III.

## The Boolean Type

A boolean value is either TRUE or FALSE. Such values result from various kinds of expressions (such as comparisons), can be used with the logical operators NOT, AND, and OR to result in new boolean values, and are used in some of the control statements of Pascal. Note that TRUE and FALSE are not numerical values.

## User-Defined Scalar Types

In Pascal, a scalar data type is one that has a fixed number of possible values which form a fixed sequence. The integer, char, and boolean types are scalar types (the sequence for char values is the sequence of the ASCII table, and the sequence for booleans is FALSE, TRUE).

You can also define your own scalar types. For example, the declaration

```
VAR DAY:(SUN, MON, TUES, WED, THURS, FRI, SAT);
```

creates a variable called DAY. The possible values of DAY are represented by the identifiers SUN, MON, etc. The actual values are internal bit patterns, of course, but you don't need to know what they are because you have the identifiers for them. The values have the ordering indicated in the declaration.

## Subrange Types

Subrange types are variations on the scalar types described above. For example, the declaration

```
VAR DAYNUM:1..7;
```

creates an integer subrange variable whose values cannot be less than 1 or greater than 7. If the program tries to give DAYNUM a value outside this range, the interpreter will halt the program with an error message. Subrange types can also be based on the char type and on user-defined scalar types, as shown in the following declarations:

```
VAR CAPITALS:'A'..'Z';
    DAY:(SUN, MON, TUES, WED, THURS, FRI, SAT);
    WEEKDAY:MON..FRI;
```

Subrange types are particularly useful for array indices.

## The String Type

The value of a string variable is a sequence of char values. Besides the value, a string variable also has a length attribute which is automatically maintained by the system when the value of the string changes during program execution. The declaration

```
VAR LASTNAME: STRING;
```

creates a variable LASTNAME of type string. The maximum length for a string is 255 characters. Apple III Pascal has a powerful set of built-in procedures and functions for manipulating string values.

## Array Types

An array is a collection of values, all of the same type. The values are called array elements. A particular element of an array can be referenced by writing the name of the array followed by one or more indices enclosed in square brackets []. The array is said to have one dimension for each of its indices.

Pascal arrays are very flexible. They can have any number of dimensions (subject to space restrictions). The elements of an array can be of any type except file types. The indices of an array can be of any subrange type (including integer subranges), or any scalar type except integer. The declaration

```
VAR NUMS: ARRAY[0..511] OF REAL;
```

creates a one-dimensional array named NUMS, with 512 elements. Each element is a real value. The first element in the array is NUMS[0] and the last is NUMS[511]. The declaration

```
VAR MATRIX: ARRAY[1..255, 1..64] OF BOOLEAN;
```

creates a two-dimensional 255x64 array of boolean values. Note that this time, the indices start at 1 instead of 0. Finally, the declaration

```
VAR CHARCODE: ARRAY[CHAR] OF 0..255;
```

creates a one-dimensional array which contains values in the range 0 to 255. The array is indexed by characters. For example, CHARCODE['A'] refers to the 66th element of the array, since the character A is the 66th character in the ASCII set.

## Record Types

Like an array, a record variable is a collection of values; but the values belonging to a record need not all be of the same type. Each element of a record variable has its own identifier. The declaration

```
VAR PERSON: RECORD
    FIRSTNAME: STRING;
    INITIAL: CHAR;
    LASTNAME: STRING;
    AGE: INTEGER
END;
```

creates a record variable PERSON which contains four values; two of the values are strings, one is a char, and one is an integer. The elements of PERSON are referred to in the program as PERSON.FIRSTNAME, PERSON.INITIAL, PERSON.LASTNAME, and PERSON.AGE.

## Set Types

The declaration

```
VAR SPECIALCHARS: SET OF CHAR;
```

creates a set variable SPECIALCHARS which is a set of characters. We say that the type char is the base type of the set SPECIALCHARS. During program execution, the actual value of SPECIALCHARS is a bit pattern which reflects the presence or absence of each character in the ASCII character set; to make use of this value, Pascal provides a notation for writing a set value as in the following assignment statement:

```
SPECIALCHARS := ['.', ':', ';']
```

This statement assigns to SPECIALCHARS the set of characters consisting of the period, colon, and semicolon characters. Pascal also provides operations for adding a new member to a set,

testing to see if a particular value is a member of the set, forming the union, intersection, or difference of two sets, and comparing sets. The base type of a set can be any subrange type (including integer subranges), or any scalar type except integer. The base type cannot have more than 512 possible values; this means that a set cannot have more than 512 members.

## Dynamic Variables and Pointers

Pascal provides a mechanism for using variables that are created during program execution, using unallocated memory space; these are called dynamic variables. A dynamic variable can be of any data type (except a file type, which is discussed in the next section). A dynamic variable is not declared; instead, a pointer variable is declared. During program execution, the pointer is used to create one or more dynamic variables. For example, consider the following declarations:

```
TYPE PREC=RECORD
    FIRSTNAME: STRING;
    INITIAL: CHAR;
    LASTNAME: STRING;
    AGE: INTEGER
END;

VAR PPTR: ^PREC;
```

The type PREC is equivalent to the type of the PERSON variable in the example for record types (see above). The pointer variable PPTR is defined as a pointer to a dynamic variable of type PREC. The program can then contain the statement

```
NEW(PPTR)
```

which creates a new dynamic variable of type PREC. This variable can be referred to in the program as PPTR^, and its elements as PPTR^.FIRSTNAME, PPTR^.INITIAL, etc.

## File Types

In Pascal, files are considered to be program variables. A file is considered to be a sequence of an indefinite number of data elements, all of the same type. The elements can be of any type except a file type. The declaration

```
VAR OUT: FILE OF INTEGER;
```

creates a file variable OUT whose elements are of type integer. Physically, a file in the Apple III system is either a diskette file or some device or device driver attached to the system; so Apple III Pascal has mechanisms for associating a file variable with an external file. A powerful set of built-in procedures is provided for doing file I/O.

## Statements

Pascal statements do the work of a Pascal program. There are ten distinct kinds of statement in Pascal; they are described here very briefly. A distinctive feature of Pascal is that some kinds of statements can contain other statements.



Pascal uses the semicolon character in two ways. In the preceding sections we have seen semicolons used to terminate declarations. In the body of a program or procedure, Pascal uses semicolons to separate statements. When a semicolon appears at the end of a statement, it is not part of the statement: it stands alone and separates the statement from the next statement. If the next thing in the text is not a statement (for example, the word END), no semicolon is required. The examples in this book use semicolons only where they are actually required.

## The Assignment Statement

An assignment statement gives a value to a variable. An example is

```
MEANVAL := (LEFTVAL + RIGHTVAL) / 2
```

where MEANVAL, LEFTVAL, and RIGHTVAL are variables of type real. The effect of this assignment statement is to calculate the sum of the current values of LEFTVAL and RIGHTVAL, divide by 2, and make the resulting value the new value of MEANVAL.

## The Procedure Call Statement

Procedures are discussed further on; they can be thought of as subprograms that are embedded in the main program. The statement

```
WRITE('ABCD')
```

is a procedure call statement that activates the WRITE procedure. WRITE is a built-in procedure; that is, it is automatically available to all Apple III Pascal programs. In the example, the procedure call statement passes the string ABCD to the WRITE procedure as a parameter; WRITE will display the string on the screen.

## The Compound Statement

In some ways this is the most important kind of statement in Pascal. It consists of the reserved word BEGIN, followed by any number of Pascal statements, followed by the reserved word END. This allows you to put any number of statements in a place where only one statement is allowed, since the compound statement is just one statement. You will see many examples of this practice. Also, the body of every program and of every procedure and function definition is a single compound statement.

## The IF Statement

The IF statement provides conditional execution of a statement which is contained in the IF statement. The condition is the value of an expression, which has a boolean value (TRUE or FALSE). An example:

```
IF A < B THEN C := D
```

In this example, the assignment statement C := D will be executed only if the expression A < B has the value TRUE--that is, if the value of A is less than the value of B. Another example:

```
IF X = Y THEN BEGIN
    MATCHCNT := MATCHCNT + 1;
    Writeln('X is equal to Y')
END
```

This shows the use of a compound statement, which will be executed only if X and Y have equal values. Inside the compound statement are two statements--an assignment statement and a procedure call. Note the use of a semicolon to separate the two statements. Also, note that just as the compound statement is a single statement containing two other statements, the entire IF statement is a single statement containing the compound statement.

An IF statement can also have an ELSE part, which is executed only if the condition is FALSE; for example,

```
IF M = 0 THEN ZEROCNT := ZEROCNT + 1
  ELSE NONZEROCNT := NONZEROCNT + 1
```

Here either ZEROCNT or NONZEROCNT will be incremented, depending on whether or not M is equal to 0.

## The CASE Statement

The CASE statement lets a program select and execute one statement from a set of statements. The CASE statement contains an expression, and the statements inside the CASE statement are labeled with possible values of the expression; thus the value of the expression selects one statement to be executed. An example:

```
CASE COMMCH OF
  'A': APPEND;
  'R': REORDER;
  'F': FORGET;
  'X': BEGIN
        WRITELN('Exiting from program');
        EXIT(PROGRAM)
      END
END
```

where the controlling expression is COMMCH (a char variable) and APPEND, REORDER, FORGET, and EXIT are procedures. If COMMCH is 'A', the first statement is executed, calling the APPEND procedure. If COMMCH is 'R', the second statement is executed to call the REORDER procedure, and so forth. Note the use of a compound statement to do two things in the 'X' case. If COMMCH does not match any of the labels in the CASE statement, none of the statements within the CASE statement are executed; the program proceeds to the next statement after the CASE statement.

## The REPEAT and WHILE Statements

These statements, like the IF statement, contain an expression whose value is boolean (TRUE or FALSE). A REPEAT statement contains one or more statements which are executed once, and then repeated if the expression's value is FALSE. Repetition continues until the expression's value is TRUE. The following example prompts the user to type the word "cat" and repeats until

the user does so:

```
REPEAT
  WRITE('Type the word "cat" ');
  READLN(INSTRING)
UNTIL INSTRING = 'cat'
```

In this example, the built-in procedure READLN reads whatever the user types (terminated with the RETURN key) and puts the characters in INSTRING.

The WHILE statement executes a single (possibly compound) statement repeatedly, as long as the value of the controlling expression is TRUE. This value is tested before anything is executed; thus in some cases the statement within the WHILE statement may not be executed at all. The following example is a variation on the previous one; note that the symbol <> means "not equal to":

```
WRITE('Type the word "cat" ');
READLN(INSTRING);
WHILE INSTRING <> 'cat' DO
  BEGIN
    WRITELN('You typed ', INSTRING);
    WRITELN('Try again:');
    WRITE('Type the word "cat" ');
    READLN(INSTRING)
  END
```

The compound statement in the WHILE statement is executed only if the user fails to type "cat" on the first try; but in this event the compound statement is executed until the word "cat" is typed.

## The FOR Statement

The FOR statement controls repetition of a single (possibly compound) statement by counting. For example, the following statement will list the integers from 1 to 10 on the screen:

```
FOR NUMBER := 1 TO 10 DO WRITELN(NUMBER)
```

where NUMBER is an integer variable which is used as the control variable of the FOR statement. First the value 1 is assigned to it. Then the WRITELN statement is executed (using the current value of NUMBER). Then the value of NUMBER is changed to the

next integer in sequence, and the `WRITELN` is executed again. The process is repeated until the value of `NUMBER` exceeds the value of the limit expression, which is `10` in this case. Thus the last number written on the screen is `10`.

The `FOR` statement can also count in reverse, by using the word `DOWNTO` instead of `TO`. The following will list the letters in reverse order from `Z` to `A`:

```
FOR CHARACTER := 'Z' DOWNTO 'A' DO WRITELN(CHARACTER)
```

Notice that in this example character values are used instead of integer values. In fact, any scalar type can be used to control a `FOR` statement.

### The WITH Statement

The `WITH` statement is a convenience for referring to the fields within a record variable without having to write the identifier of the record repeatedly.

### The GOTO Statement

The `GOTO` statement causes an unconditional "jump" to a specific statement. There are some important restrictions on the use of `GOTO` in Apple III Pascal; see Chapter 5 for details.

## Expressions

Pascal expressions are "algebraic" in form. An expression can contain just a single value, such as a variable identifier or a constant, or it can be a complex combination of various operands and operators.

### Arithmetic Operators

For arithmetic operations with real and integer operands, the operators are

<code>+</code>	addition
<code>-</code>	subtraction or negation
<code>*</code>	multiplication
<code>/</code>	division with real result
<code>DIV</code>	division of integers with integer result rounded toward zero
<code>MOD</code>	remainder of integer division



In Apple III Pascal, all arithmetic operations on real values conform to the proposed IEEE floating-point standard. See Appendix E for complete details.

### Comparison Operators

Comparisons between scalar or real operands, yielding boolean results, are performed by the operators

<code>&gt;</code>	greater than
<code>&gt;=</code>	greater than or equal to
<code>=</code>	equal to
<code>&lt;=</code>	less than or equal to
<code>&lt;</code>	not equal to

### Logical Operators

Logical operations with boolean operands and boolean results are performed by the operators

<code>NOT</code>	boolean negation
<code>AND</code>	boolean conjunction
<code>OR</code>	boolean disjunction

### Set Operations

Set operations with set results are performed by the operators

<code>+</code>	union
<code>-</code>	difference
<code>*</code>	intersection

Set comparisons, with boolean results, are performed by the operators

```

=          equal to
<>        not equal to
>=        includes or is equal to
<=        is included by or equal to
IN         is a member of

```

Notice that some of the operator symbols are used in more than one way: for example, the + symbol can be the numeric addition operator or the set union operator. In such a case, the meaning of the operator symbol depends on the operands.

## Procedures

A procedure can be thought of as a "subprogram," which is defined (that is, written) inside the main program (before the main program's body of executable statements) and can then be executed by the main program, using a procedure call statement.

An example of a procedure definition:

```

PROCEDURE TWOLINES;
  BEGIN
    WRITELN;
    WRITELN;
  END;

```

This procedure does nothing but call the WRITELN procedure twice; this displays two blank lines on the screen. A more useful procedure would be

```

PROCEDURE NINES (NUMBER: INTEGER);
  VAR COUNTER: INTEGER;
  BEGIN
    FOR COUNTER:=1 TO NUMBER DO WRITELN
  END;

```

This procedure has a parameter: an integer value which is called NUMBER within the procedure definition. The value of NUMBER is determined when NINES is called by a statement such as

```
NINES(5)
```

which gives the value 5 for the parameter. NINES uses the value of NUMBER as the limit value in a FOR statement; the procedure

call statement NINES(5) would cause NINE to put five blank lines on the screen.

Notice that in order to use the FOR statement, NINES needs an integer variable to control it. Therefore NINES contains a declaration of the integer variable COUNTER. This variable belongs to NINES and is unknown to the rest of the program. In fact, the main program could have another variable with the same name, COUNTER, and this would not cause any problems.

Every procedure has the following general outline:

procedure heading,  
 consisting of the word PROCEDURE, the procedure's name,  
 and a list of any parameters;

declarations of any user-defined data types,  
 constants, variables, etc.

definitions of any procedures and functions

the word BEGIN

any number of statements, separated by semicolons

the word END, followed by a semicolon

Compare this to the structure of a program shown in the previous chapter. The underlines indicate the only differences between a procedure definition and a program. Note that procedure definitions can be written inside other procedure definitions; when this is done, the inner procedure belongs to the outer one, and is unknown to the rest of the program.

For more about procedures, see Chapter 6.

## Functions

A function is a procedure that returns a value. While a procedure call is a statement, a function call is an operand in an expression. The function calculates a value, and this value becomes the value of the operand in the expression. The following function calculates the cube of a real value:

```

FUNCTION CUBE (V: REAL): REAL;
BEGIN
  CUBE := V * V * V
END;

```

Note that the function heading includes the type of the value calculated by the function. Within the function, the function name appears on the left side of an assignment statement; this establishes the value that the function returns. The CUBE function could be used in an expression as follows:

```
CUBE(5.7*Y) + 2.3
```

In evaluating this expression, the value of Y is first multiplied by 5.7. The result is the parameter value to be passed to CUBE. The CUBE function is then executed, and it calculates the cube of the parameter value. This value then becomes the first operand in the expression; 2.3 is added to it to get the value of the expression.

For more about functions, see Chapter 6.

## ***Built-In Procedures and Functions***

Pascal has a large set of procedures and functions built into it. These procedures and functions do not have to be defined; they do not reside in a library; they are part of the language itself and are automatically available to all programs. They serve such purposes as control of input and output, various mathematical functions, manipulation of strings, use of dynamic variables, and various special purposes. Further information on the built-in procedures and functions is in various chapters, along with the topics that the procedures and functions relate to.

## ***Pascal Program Structure***

Chapter 1 gives an outline of the structure of a Pascal program. We can now show the structure in a slightly more sophisticated way. First we define something called a block.

Every block has the following outline:

- optional label declarations—the word LABEL followed by declaration of labels
- optional constant declarations—the word CONST followed by declarations of identifiers for constants
- optional type declarations—the word TYPE followed by declarations of user-defined data types
- optional variable declarations—the word VAR followed by declarations of variables
- optional definitions of procedures and functions
- one compound statement

The LABEL declaration has been mentioned briefly; it is only needed in a block that uses GOTO statements.

The idea of a block is important in Pascal. For one thing, we can now say that the outline of every program is

- program heading
- optional USES declaration
- block
- period

(The USES declaration is explained below.) Similarly, the outline of every procedure definition is

- procedure heading
- block
- semicolon

and the outline of every function definition is



function heading

block

semicolon

## The Scope of Identifiers

The scope of an identifier is simply the part of the program in which it is known. Here are the rules about the scope of identifiers:

- An identifier that is declared in a procedure or function is not known outside of that procedure or function. This includes the identifiers of parameters in the procedure or function heading.
- A procedure or function can re-declare an identifier which was already declared outside the procedure or function. In this case there are two different things that happen to have the same identifier, but there is no problem: the "outer" identifier is unknown inside the procedure or function, and vice versa.
- The identifier of a procedure or function is considered to be declared both inside and outside the procedure or function. That is, the identifier is known both inside and outside and you cannot re-declare it.

To see how this works, consider the following fragment of a program:

```
PROGRAM SAMPLE;

CONST MSG = 'Limit exceeded.';

VAR LIMIT:REAL;

PROCEDURE TSTLIM (X: INTEGER);
  CONST LIMIT=3;
  BEGIN
    IF X > LIMIT THEN WRITELN(MSG)
  END;

BEGIN
  .
  .
  .
```

The string constant MSG is known throughout the program, including the procedure TSTLIM. We say that MSG is local to the program and global to TSTLIM.

The integer variable X, declared in the procedure heading of TSTLIM, is known only inside TSTLIM. We say that X is local to TSTLIM and unknown to the program.

The real variable LIMIT is known throughout the program, except inside TSTLIM, because the integer constant LIMIT is declared within TSTLIM. The integer constant LIMIT is local to TSTLIM and unknown to the program—while the real variable LIMIT is local to the program and unknown to TSTLIM.

The example shows a procedure within a program, but exactly the same rules apply when a procedure or function is nested within another procedure or function.

This scoping of identifiers becomes a real advantage when a program is large or complex. It means that you (or some other programmer) can develop a procedure without worrying about whether the procedure's variables will conflict with the main program's variables.

## Library Units

A library unit is a package of "public" procedures, functions, variables, etc. that has been compiled separately and placed in a library file. A file named SYSTEM.LIBRARY is an integral part of

the system and contains a number of standard packages. These packages provide such things as transcendental functions, graphics functions, and access to special Apple III machine features.

A program that uses a library unit has access to all the public features of that unit, just as if they were declared at the beginning of the program. To use a unit, the program merely gives the name of the unit in a USES declaration immediately after the program heading. For example, two of the standard units are called TRANSCEND and APPLESTUFF. To use both of them, a program would have the declaration

```
USES TRANSCEND, APPLESTUFF;
```

immediately after the program heading.

## Sample Program

At the end of Chapter 1, a sample program was given without explanation. Now we can explain how the program works.

```
PROGRAM FIRSEXAMPLE;           { program heading }
VAR I:INTEGER;                 { declaration of
                               a variable }
PROCEDURE DISPLAY (J:INTEGER); { procedure definition }
BEGIN
  WRITELN;
  WRITELN('The number is ', J)
END;                           { end procedure
                               definition }
BEGIN                          { begin program body }
  FOR I:=0 TO 10 DO DISPLAY(I)  { statement }
END.                            { end of program }
```

One procedure, DISPLAY, is declared. DISPLAY accepts one parameter, an integer value which is known within the procedure as J.

Notice that the program body contains just one statement: a FOR statement that repeats for values from 0 through 10. The FOR

statement is controlled by the integer variable I, declared in the VAR declaration at the beginning of the program.

Each time the FOR statement executes, it executes a procedure call to the DISPLAY procedure. The procedure call passes the current value of I to DISPLAY. DISPLAY assigns this value to its own variable J. DISPLAY then executes two statements:

- First it calls the built-in procedure WRITELN with no parameters. This causes a blank line to be displayed on the screen.
- Then it calls WRITELN again with two parameters (separated by the comma). The first parameter is the string constant 'The number is ', and the second is the integer value J. WRITELN displays these values on one line on the screen.

Each time DISPLAY is called, the value of I is passed to it as the value for J. Since I is the control variable of the FOR statement, it takes on the values 0 through 10 in sequence. Therefore, the output from the program is

```
The number is 0
The number is 1
The number is 2
The number is 3
The number is 4
The number is 5
The number is 6
The number is 7
The number is 8
The number is 9
The number is 10
```

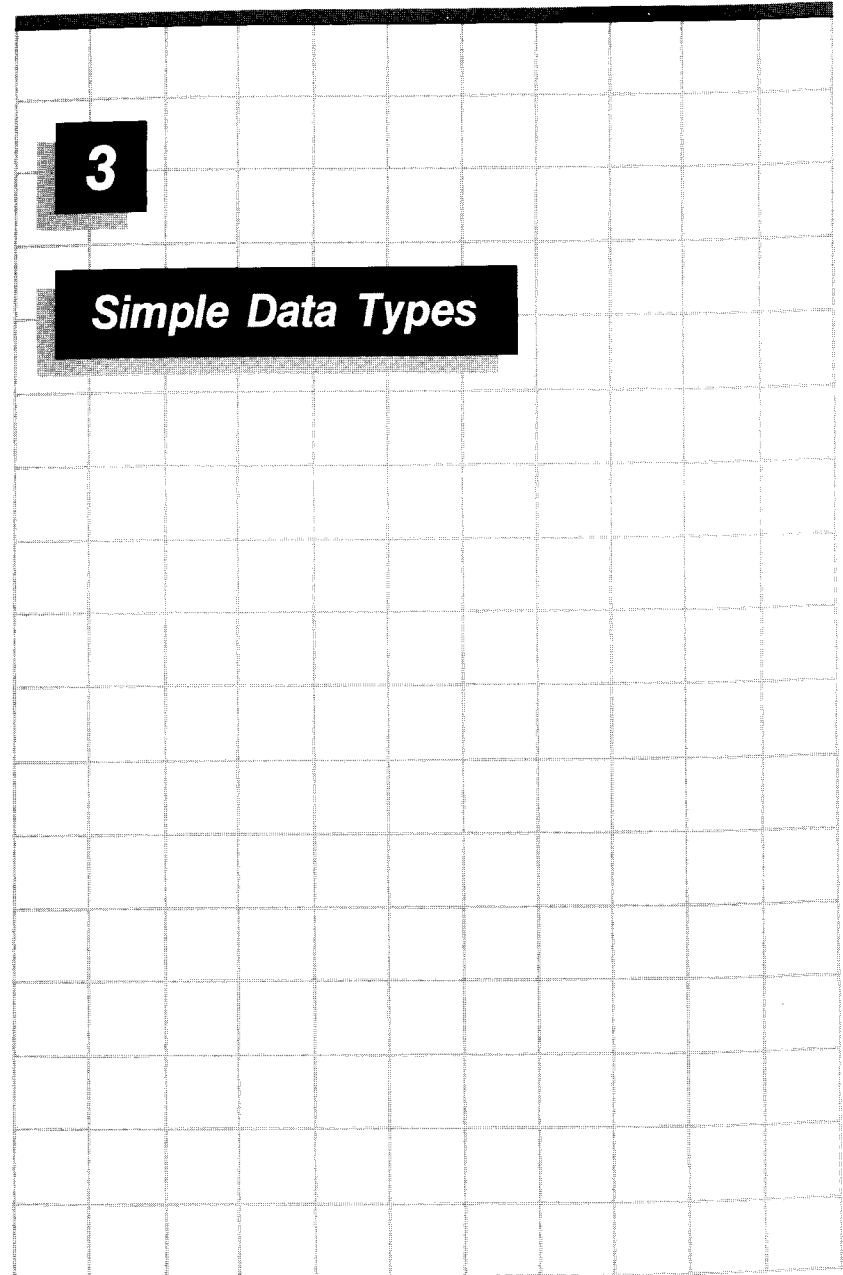

## Introduction

Every piece of data used or created by a Pascal program has an attribute called its type. The type tells the program and the system how to interpret the piece of data. For example, one of the fundamental types is the integer type; another distinct type is the real type. An integer value is a signed whole number, while a real value is a signed floating-point number. You can think of a data type as a definition of the set of possible values that the data can have.

If the piece of data is the value of a named constant or variable, its type is assigned when the constant or variable is declared. Otherwise, the type of the data depends on how the program inputs or creates the data.

Pascal offers an especially wide range of built-in types, each with its own identifier. Pascal also allows you to define your own types within a program. A user-defined type can be a composite of built-in types, for example, or it can be a subrange of a built-in type. In this chapter, we cover the simple data types—i.e. the types that a single value can have. These are

- The type REAL
- The scalar types:
  - INTEGER and LONG INTEGER
  - CHAR
  - BOOLEAN
- User-defined scalar types
- Subrange types

Other chapters will cover the structured data types, where a typed piece of data can be a collection of various single values.



Jensen and Wirth, in their definition of Pascal, define the type REAL to be a scalar type. Most books on Pascal follow Jensen and Wirth on this point. But REAL values are not handled in the same way as values of other scalar types, and are an exception to most of the rules about scalars; therefore, this book considers reals to be a separate category.

## Declarations

As described in the previous chapter, the structure of a Pascal program includes sections for several different kinds of declarations. Here is a sample program that uses two kinds of declarations:

```
PROGRAM XYZ;

CONST MAXA = 24;           {An integer constant}
      MAXB = 31;           {Another integer constant}
      COEFFICIENT = 17.3; {A real constant}

VAR A : INTEGER;          {An integer variable}
    B : INTEGER;          {Another integer variable}
    X : REAL;              {A real variable}

BEGIN
  FOR A := 0 TO MAXA DO
    FOR B := 0 TO MAXB DO
      BEGIN
        X := A + B*COEFFICIENT;
        WRITELN(X)
      END
    END
  END.
```



Note that different kinds of declarations must be placed in a specific order in the program. Variables are always declared last, and constants are always declared before variables. There are also several other kinds of declarations; further on in this chapter we will see type declarations.

## Declaring Constants

Generally, constants do not have to be declared; however, it is often a convenience to do so. When you declare a constant, you are creating an identifier and associating it with a specific, unchanging value. All constant declarations are grouped together and introduced by the reserved word CONST.

The syntax diagram for constant declarations is

constant declarations

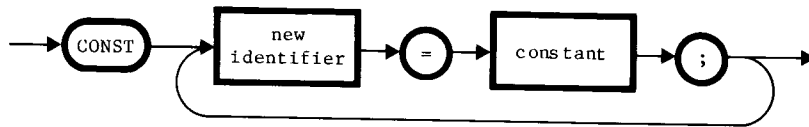

Note the use of the "=" symbol, and note that each declaration ends with a semicolon. In this diagram, "constant" can be any of the following:

- A signed or unsigned whole number representing a value of type INTEGER. (See section further on for LONG INTEGER numbers).
- A signed or unsigned floating-point number representing a value of type REAL.
- A character or string of characters enclosed in apostrophes, representing a value of type CHAR or type STRING. A single character string constant is identical to a constant of type CHAR. Strings are explained in Chapter 7.
- The identifier of a previously declared constant (to create a new constant with the same value and a different identifier).

The following example declares two constants:

```
CONST PI = 3.14159;
      MAXITERATIONS = 10;
```

The first constant, PI, has the value 3.14159, and the second, MAXITERATIONS, has the value 10. PI is a constant of type real and MAXITERATIONS is a constant of type integer.

You can use the constant PI wherever a real value is allowed; for example, in the expression

```
2 * PI * RADIUS
```

where RADIUS is a variable. In this expression, 2 is an example of an integer constant that has not been declared. Incidentally, the integer value 2 is automatically converted to the real value

2.0 before the multiplication takes place (for details, see Chapter 4).

Declaring a constant such as PI is a convenience, not a necessity; you could write

```
2 * 3.14159 * RADIUS
```

and it would mean exactly the same thing.

### Declaring Variables

All variables must be declared. When you declare a variable, you are creating an identifier and associating it with a specific data type; when the program is executed, the variable can take on any of a set of values depending on the type. All variable declarations are grouped together and introduced by the reserved word VAR.

The following example declares two variables:

```
VAR RATIO: REAL;
    ITERATION: INTEGER;
```

Again, each declaration ends with a semicolon. The first variable, RATIO, is of type real, and the second, ITERATION, is of type integer. When two or more variables of the same type are declared, you can combine the declarations:

```
VAR I, J, K: INTEGER;
    X, Y, Z: REAL;
```

This declares three integer variables, I, J, and K, and three real variables, X, Y, and Z.

In the remainder of this chapter, you will see many examples of variable declarations, using many different data types. However, all of them follow the general form of the examples just given. The syntax diagram for variable declarations is

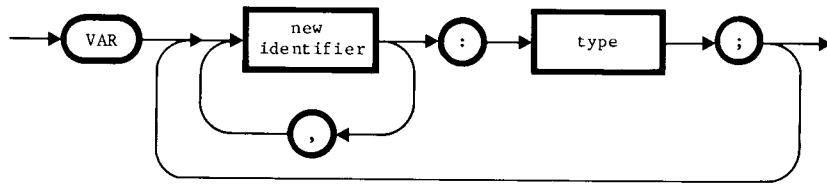
variable declarations

Note the use of the ":" symbol, and note that each declaration ends with a semicolon. The word "type" in the diagram stands for any of a wide range of possibilities. In this chapter we are concerned with certain predefined types, which are represented by identifiers such as INTEGER and REAL; we will also introduce two of the ways in which you can define new data types.

## The Real Type

A value of type real is a signed floating-point number. It is stored as a 32-bit number following the IEEE format. Real values can be combined with each other by means of the arithmetic operators +, -, \*, and / to yield real results. A real value can also be combined arithmetically with an integer value; when this happens, the integer value is first automatically converted to a real value, and the result is real.

An integer value is also automatically converted to a real value when it is assigned to a real variable. A real value can be converted to an integer value in either of two ways: the TRUNC function and the ROUND function. These built-in functions are described in the last section of this chapter.

A real value can be compared arithmetically with another real value or with an integer value by means of the <, <=, =, >=, >, and <> operators, to yield boolean results.

The range of real values is from plus or minus 1.401298464E-45 to 3.402823466E38; 0.0 is also a real value. Each real value is represented in 32 bits (two 16-bit words, or four 8-bit bytes). This gives a precision of about 7 significant digits (depending on the actual value).



**Warning:** do not confuse the Pascal type real with the mathematical idea of a real number. The Pascal type is a floating-point bit pattern or code which can be used to represent a number in the computer. These codes and the operations on them do not always correspond exactly to their mathematical counterparts.

For example, if the exact result of an operation on reals can't be represented in the 32-bit format, it is automatically rounded to fit. Subsequent calculation with this rounded value may make later results approximate as well. It is a wise precaution to analyze your program carefully, anticipating errors from this cause. See Appendix E for further information.

## Declaring Real Variables

As shown in the examples above, real variables are declared by using the word REAL to the right of the colon in the declaration.

## Declaring Real Constants

A constant of type real can be declared in a constant declaration with a literal floating-point number to the right of the equal sign (read on for examples). The syntax for a floating-point number is

### floating-point number

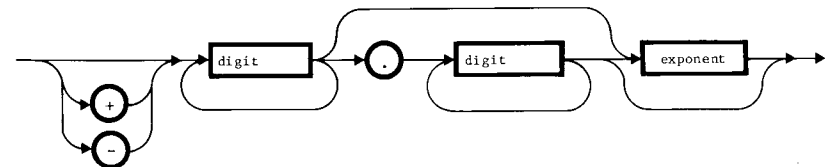

and the syntax for an "exponent" is

exponent

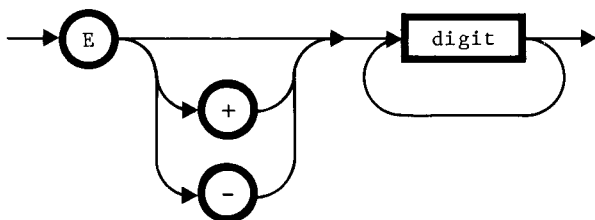

Examples are

3.14159 2.0 -3.5 12.6E3 7.8236E-12 -83769E-3

The "E" notation indicates a power of ten; for example, 12.6E3 and 12600.0 mean the same thing. Note that the last example has no decimal point; this shows that if a numeric constant has either a decimal point or an "E" in it, it is considered to be a real constant. Finally, note that if there is a decimal point, it must have at least one numeric digit on either side of it.

## Scalar Types

A scalar data type has a distinct set of possible values, which are considered to be ordered in a specific way: they can be put in one-to-one correspondence with some sequence of possible values of type integer. There are three built-in scalar types, namely integer, char, and boolean; these are described below. Also, you can create your own scalar types.

In Apple III Pascal, the type real is not a scalar type by this definition; the reason is that there are not enough integer values to match up with all the possible real values.

## The Integer Type

Integer values are whole numbers in the range from -32768 through 32767. Integer values can be combined with each other by means of the arithmetic operators +, -, \*, DIV, and MOD to yield integer results, or by means of the / operator to yield a real

result. An integer value can also be combined arithmetically with a real value; when this happens, the integer value is first automatically converted to a real value, and the result is real.

An integer value can be compared arithmetically with another integer value or with a real value by means of the <, <=, =, >=, >, and <> operators, to yield boolean results.

An integer value is automatically converted to a real value when it is assigned to a real variable.

## Declaring Integer Variables

As shown in the examples above, integer variables are declared by using the reserved word INTEGER to the right of the colon in the declaration.

## Declaring Integer Constants

A constant of type integer can be an identifier previously declared in a constant declaration or a non-floating-point number. The syntax for a non-floating-point number is

non-floating-point number

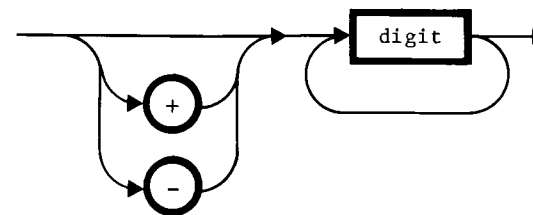

Examples are

1 0 -3 23583 -4532

Note that a non-floating-point number is one that contains neither a decimal point nor the letter "E". Note also that -32768 cannot appear as an integer constant in a program.

## MAXINT

MAXINT is the identifier of a built-in constant whose value is the largest possible integer, 32767.

## The Long Integer Type

This is a special-purpose type. A long integer variable contains a signed whole number represented internally as a sequence of up to 36 binary-coded decimal (BCD) digits. The maximum number of digits is specified by a length attribute in the declaration of the variable. For example, the declaration

```
VAR CENTS: INTEGER[9];
```

creates a long integer variable named CENTS which can represent a value of up to 9 decimal digits. You can specify a length attribute up to and including 36. (The actual limit, at run time, may be greater than the number you specify.)

There are also long integer constants; any constant whose value is a non-floating-point number greater than 32767 (the largest integer) or less than -32768 (the least integer) is a long integer constant.

An integer value can be assigned to a long integer variable; it is automatically converted to a long integer value. A long integer value cannot be directly assigned to an integer variable; however, if it is not greater than 32767 or less than -32768 it can be converted to an integer value by means of the TRUNC function described further on in this chapter.

Long integers cannot be used as freely as integers. Long integers can be combined with each other by means of the +, -, \*, and DIV operators (but not the / and MOD operators), to give long integer results. With the same operators, a long integer value can be combined with an integer value; the integer value is automatically converted to a long integer and the result is of type long integer.



In long integer arithmetic, overflow occurs if any intermediate or final result would exceed 36 digits. This causes a run-time error halt.

Note that long integer is not a scalar type, for the same reason that real is not a scalar type--there are more possible long integer values than there are integer values. Long integers are mentioned here simply because they are conceptually related to integers.



The standard system library file, SYSTEM.LIBRARY, contains a library unit called LONGINTIO. Long integer operations cannot be executed unless this unit is available to the program at start of execution.

## The Char Type

A char value is any character from the 8-bit ASCII character set used on the Apple III. Thus the char values correspond to the integers from 0 to 255; the integer associated with each char value is called its ASCII code. The first 128 char values (ASCII 0 through ASCII 127) have standard interpretations as printing characters and control characters, as shown in the ASCII code table in Appendix J. The remaining char values can also be used as explained below in the section on the CHR function.

A char variable is declared by using the reserved word CHAR in the declaration. For example, the declaration

```
VAR CURRENT_CH, LAST_CH: CHAR;
```

declares two variables (CURRENT\_CH and LAST\_CH) of type char.

A character constant is formed by placing the character between apostrophes (single quotes), as in the following examples:

```
'a' '5' '' '' ',' ''
```

Note that the value of the third constant is the apostrophe character; this is a special notation. The value of the last constant is the space character.



A character constant can be declared, as in the following example:

```
CONST FLAG_CH = '^';
```

## The CHR Function

In the 8-bit ASCII set there are numerous character values that cannot be represented as char constants, since they cannot be entered from the keyboard when you are using the Editor. To represent such char values (and for other purposes), Pascal has a built-in function, CHR. To use this function, the form is

```
CHR ( expression )
```

where the expression can be any expression with an integer value in the range from 0 to 255. Note that this can be just an integer constant, namely the ASCII code for the desired character. For instance, the value of

```
CHR(0)
```

is the "NUL" (null) character, whose ASCII code number is 0.



The ASCII codes in the range 128 through 255 are not assigned to specific characters, but are nevertheless usable as ASCII code values; thus CHR(200) is a valid function call and returns "the character whose ASCII code is 200" even though this does not have a standard interpretation. These characters can be generated on the keyboard by holding down the Open Apple key and typing a character. The Open Apple key sets the high bit of the 8-bit ASCII code to 1, which has the effect of adding 128 to the code shown in the ASCII code table in Appendix J.



The CHR function does not check its parameter value to make sure it is in the range 0 through 255. If the parameter value is outside this range, CHR will return an undefined character value.

## The Boolean Type

By definition, there are only two boolean values, represented by the words FALSE and TRUE. These words are actually identifiers for built-in constants, whose values represent a logical "false" result and a logical "true" result, respectively. These are not numerical values (though of course they are represented internally as binary numbers). FALSE is less than TRUE.

Boolean values are created in various ways; in particular, the results of comparison operations are boolean values. For example, the value of the expression

```
LEGAL_AGE > AGE
```

(where LEGAL\_AGE and AGE are integer variables) is either TRUE or FALSE. An important use for boolean values is in controlling the program. For example, a boolean value can be used to control an IF statement:

```
IF LEGAL_AGE > AGE THEN WRITE('Below legal age.')
```

The WRITE statement is executed if and only if the boolean value of LEGAL\_AGE > AGE is TRUE.

Boolean variables are declared by using the reserved word BOOLEAN in the declaration. For example, the declaration

```
VAR FLAG1, FLAG2: BOOLEAN;
```

creates two boolean variables, FLAG1 and FLAG2.

You can also declare boolean constants, by giving FALSE or TRUE as the value.

## Defining New Scalar Types

The boolean type is an example of a data type where the values are represented by identifiers. The "meaning" of these values is in the way they are used. You can define a new scalar type by listing the identifiers for its values. For example, the

**declaration**

```
VAR FIDDLE: (BASS, CELLO, VIOLA, VIOLIN);
```

creates a variable, FIDDLE, whose possible values are the listed identifiers from BASS to VIOLIN. These four identifiers are constants. They correspond to the integers 0, 1, 2, 3, so that they are strictly ordered; for example, the value CELLO is less than the value VIOLA.

The syntax diagram for a declaration of a user-defined scalar type is

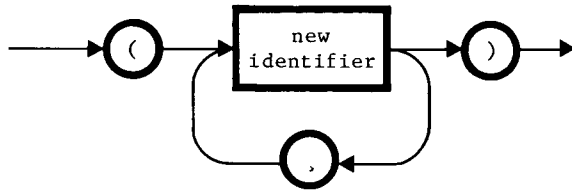
user-defined scalar type

Like boolean values, these user-defined scalar types are useful for control purposes; examples will be found in Chapter 5.

It is often useful to declare a new type explicitly. For example, instead of declaring FIDDLE in the manner shown above, you could first declare the type as follows:

```
TYPE STRING_INSTRUMENT = (BASS, CELLO, VIOLA, VIOLIN);
```

and then declare

```
VAR FIDDLE: STRING_INSTRUMENT;
```

## Subrange Types

Subrange types are used to provide automatic run-time range checking. A subrange type is based upon some scalar type which is called the "base type." The subrange type is exactly like the base type, except that its possible values are a subset of the possible values of the base type. For example, the declaration

```
VAR X: 0..255;
```

creates a variable X which is exactly like an integer variable except that it can only have values from 0 to 255. If the program attempts to give X a value less than 0 or greater than 255, it will be halted with an error message. Another example:

```
TYPE CAPITAL_LETTER = 'A' .. 'Z';
```

This creates the new type CAPITAL\_LETTER, whose possible values are the capital letters from 'A' through 'Z'.

You can create a subrange type based on any scalar type, including user-defined scalars. For example,

```
TYPE LOW_STRING = BASS .. VIOLA;
```

creates the type LOW\_STRING, which is a subrange of the type STRING\_INSTRUMENT in a previous example. The syntax for a subrange type is

subrange type

where the two constants must be of the same type (the base type).

A subrange type is a scalar type. The possible values of a subrange type cannot be distinguished from the values of the base type that fall in the same range.

## Built-In Functions For Scalar Types

To make good use of the properties of scalar types, Pascal provides a special set of built-in functions. (Recall that a function is a subroutine that accepts one or more values as parameters, and returns one value as a result.) We have already seen the CHR function, which takes an integer as its parameter and returns the corresponding character as its result. The other

special functions for scalars are ORD, PRED, and SUCC.

### The ORD Function

For any scalar type, each possible value corresponds to a unique integer. This integer is called the ordinality of the scalar value. For values of type integer, the ordinality of each value is the same as the value itself. For all other scalar types, the ordinalities begin at  $\emptyset$  for the first value and count up as far as necessary.

The ORD function accepts any scalar value as its parameter, and returns the ordinality of that value. The ORD of any single character is its ASCII code. Examples:

```
ORD(-5) is -5
ORD('A') is 65 (the ASCII code for 'A')
ORD(FALSE) is  $\emptyset$ 
ORD(TRUE) is 1
ORD(VIOLA) is 2 (given the declaration shown above)
```



ORD of a boolean value may in some cases return a value other than  $\emptyset$  or 1, and should be avoided.

### The SUCC and PRED Functions

Within any scalar type, each possible value except the last has a successor. The successor is simply the next value in sequence, according to the ordering of the type. Also, each possible value except the first has a predecessor, which is the value that precedes it. The SUCC function takes any scalar value and returns its successor (if it has one). The PRED function takes any scalar value and returns its predecessor (if it has one). For example:

```
SUCC(-5) is -4
PRED('c') is 'b'
SUCC(CELLO) is VIOLA (given the declaration shown above)
```



SUCC of the last possible value of a scalar type, or PRED of the first possible value, will return an undefined value. This can cause program bugs. It is up to the program to avoid this situation by checking parameters for SUCC and PRED to make sure that the successor or predecessor exists.

## Numeric Functions

A set of simple numeric functions is built into Pascal. Each takes a single numeric value as its parameter, and returns a single value. The first two functions, ROUND and TRUNC, convert real values to integer values. Note that there is no need for a function to convert integer values to real values; they are automatically converted whenever necessary.

### The ROUND Function

The ROUND function takes a real value as its parameter and returns an integer value, which is obtained by rounding the real value to the nearest integer. If the parameter is halfway between two integers, then it is rounded away from zero. (Rounding algorithms are discussed in detail in Appendix E.) For example,

```
ROUND(723.3) is 723
ROUND(-5.7) is -6
ROUND(7.7E3) is 7700
ROUND(43.5) is 44
ROUND(-43.5) is -44
```

### The TRUNC Function

Like the ROUND function, TRUNC takes a real parameter and returns an integer value; however, the integer is obtained by dropping (truncating) the fractional part of the real value. For example,

```
TRUNC(723.3) is 723
TRUNC(-5.7) is -5
TRUNC(7.7E3) is 7700
```

---

TRUNC can also accept a long integer value and convert it to an integer value. However, the long integer parameter must not be greater than 32767 or less than -32768.

### *The ABS Function*

The ABS function takes either a real value or an integer value as its parameter, and returns a value of the same type. The value returned is the absolute value of the parameter--that is, if the parameter is negative the sign is changed to positive. For example,

```
ABS(3.6545) is 3.6545
ABS(-3.6545) is 3.6545
ABS(-512) is 512
```

### *The SQR Function*

The SQR function takes either a real value or an integer value as its parameter, and returns a value of the same type. The value returned is the square of the parameter.

### *The ODD Function*

The ODD function takes an integer value as its argument, and returns a boolean value. The value returned is TRUE if the integer is odd and FALSE if the integer is even.

### *Library Functions*

A set of trigonometric and exponential functions and a square-root function are provided as a library unit called TRANSCEND. This is described in Appendix A.

**4****Expressions and Assignments**

## Introduction

In Pascal the value of a variable is changed by the assignment statement. The syntax of an assignment statement is

### assignment statement

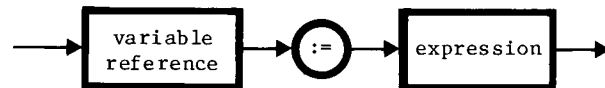

A variable reference is a reference to a specific, previously declared variable of any type. The syntax is

### variable reference

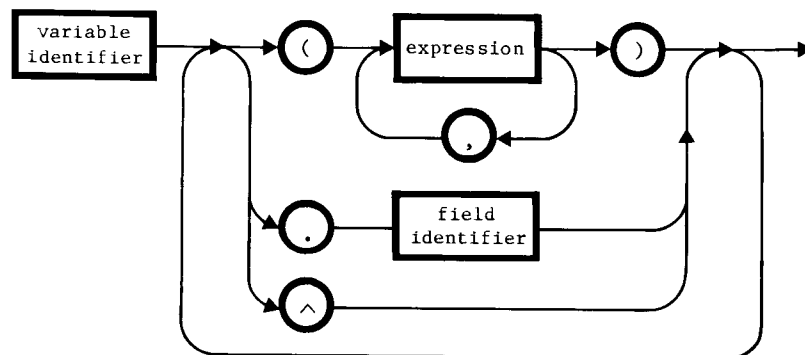

In other words, a variable reference is an identifier which may have a number of "qualifications" appended to it. Each "qualification" is either an array subscript notation in square brackets, a record field identifier set off by a period, or the ^ symbol to indicate the object of a pointer. Arrays, records, and pointers are fully explained in other chapters.

The symbol := is known as the assignment operator. It means that the expression on the right-hand side of the assignment operator is to be evaluated, and the result is to become the new value of the variable that is referred to on the left-hand side.

In its simplest form, an expression may be a constant, a variable reference, or a function call. More generally, an expression is a combination of operands and operators.

An operand is a single value, such as a constant, variable reference, or function call. Two operands can be combined by means of an operator, such as \*, +, -, or <=. Examples:

```

X <= XLIMIT
RAINFALL.OLDVAL + INCREMENT
MARGIN[INDEX] - 3
  
```

There are also operators that take only one operand: the NOT operator takes a single operand, and the + and - operators may take a single operand. Examples:

```

-X
NOT TSTRESULT
  
```

The simplest form of an operand is a variable reference or a constant. Examples of assignments which use operators that take two operands are:

```

RESULT := ONEOPERAND * ANOTHEROPERAND;
TRUTH := BIGINTEGER >= LITTLEINTEGER;
FALSITY := MYDOG > YOURDOG;
  
```

The operands in an expression can be much more complex than this; in fact, an operand itself can be an expression (which may be enclosed in parentheses, depending on context). Notice that this allows expressions to be complicated nestings of operations. Some slightly more sophisticated assignment statements are:

```

CHAMBER.PRESSURE := N * R * CHAMBER.TEMP / CHAMBER.VOL;
FINISHED := (TEST = TRUE) AND (ERROR = FALSE);
ANSWER[K] := TRUNC(SQR(COS(THETA[K])));
  
```

## Precedence of Operators

Pascal expressions often contain more than one operator. The rules of precedence determine the way in which the operations within the expression are grouped. If there were no precedence, the expression:

$$A - B * C / D + E$$

would be evaluated from left to right as if it read:

$$(((A - B) * C) / D) + E$$

But the operators do have precedence. For example, the \* and / operators are always applied before the + and - operators, regardless of the sequence in the expression (unless parentheses are used to overrule the precedence). The above example is actually evaluated as if it read:

$$(A - ((B * C) / D)) + E$$

The operations are grouped this way because \* and / have higher precedence while + and - have lower precedence.

Pascal has four different levels of operator precedence, as shown in the following table:

ORDER OF PRECEDENCE	OPERATORS	DESCRIPTION
1	NOT	NOT operator
2	* / DIV MOD AND	Multiplying operators
3	+ - OR	Adding operators
4	= < > <= >= > < IN	Relational operators

In this table, each line contains operators of equal precedence. The NOT operator has the highest precedence.

In an expression all of the operators of the highest level are applied before any of the operators of the next level are applied. If an expression contains more than one operator of the same precedence they are applied from left to right.



The precedence table is one of the significant differences between Pascal and many other languages. For example, in many languages AND and OR have the same precedence. Also, in Pascal each operator symbol always has the same precedence even if it has two possible meanings; e.g. the + operator can mean arithmetic addition or set union (depending on its operands) but it has the same precedence in either case. The virtue of Pascal's precedence table is that it is extremely easy to remember.

A portion of an expression that is enclosed in parentheses is called a subexpression. A subexpression is evaluated as if it were an independent expression, before it is combined with any other parts of the expression. If there are nested parentheses

(parentheses within parentheses) in the expression, the innermost subexpression is evaluated first. Parentheses can be used, as in ordinary algebra, to override the precedence of operators.

Here are a few examples of how expressions are evaluated:

	EXPRESSION	EVALUATED AS	RESULT
1.	$4 + 3 * 2 - 1$	$(4 + (3 * 2)) - 1$	9
2.	$8 * 2 > 5 + 6$	$(8 * 2) > (5 + 6)$	TRUE
3.	$2 > 1 \text{ AND } 4 < 5$	$(2 > (1 \text{ AND } 4)) < 5$	illegal!
4.	$5 \text{ MOD } 4 + 3$	$(5 \text{ MOD } 4) + 3$	4

In expression 1, the multiplying operator \* is applied first, as if the expression were written  $4 + (3 * 2) - 1$ . Since + and - are both of the same precedence, the remaining expression is evaluated from left to right, giving 9 as result.

Expression 2 is a relational operation between two arithmetic operations. The \* operator is applied first, then the + operator, then the > operator. Because  $8 * 2$  is greater than  $5 + 6$ , the result of the entire expression is TRUE.



Expression 3 appears to be a boolean operation between the results of two relational operations. The highest precedence operator, however, is AND which is applied to 1 and 4. Because AND requires boolean operands, this expression is ILLEGAL. It could be properly written as  $(2 > 1) \text{ AND } (4 < 5)$ .

Expression 4 is evaluated exactly as it is written.

If a function call appears in an expression, the function is called, and a value is returned, before that value is used as an operand of some operator.



The precedence rules specify the order of performance of operations. However, do NOT make any assumptions about the order of evaluation of operands.

## The Arithmetic Operators

The arithmetic operators, used with operands of type integer, long integer, and real, are:

*	multiplication
/	division with real result
DIV	division of integers with integer result
MOD	remainder of integer division
+	addition
-	subtraction or negation

Each operator has specific rules concerning what type of operands it may take, and what type of results are produced. A universal rule is that no arithmetic operator may be used to combine a real operand with a long integer operand.



In Apple III Pascal, the arithmetic operations on real values conform to the proposed IEEE floating-point standard. Under default conditions, these operations behave in ways that are familiar to most programmers. However, some subtle variations in the execution of operations on real values are available by methods described in Appendix E.



Remember that each type of result has size constraints. An integer result must fall within the range -32768 to 32767 while a long integer result cannot exceed 36 decimal digits (not including sign). A real result must have an absolute value in the range 1.401298464E-45 to 3.402823466E38, or 0.0.

Integer arithmetic overflow occurs when an integer arithmetic operation results in a final or intermediate result outside the limits given above. This does not cause an error halt; instead it produces an undefined integer result. It is up to the programmer to be sure that integer arithmetic will not overflow.

Real arithmetic overflow occurs when a real arithmetic operation would result in a final or intermediate result

with an absolute value greater than the upper limit given above. This causes an error halt under default conditions; see Appendix E for details. A real result with an absolute value less than the lower limit does not cause an error; it produces a result of 0.0.

## The \* Operator

Multiplication is done with the \* operator. The results of multiplication operations are as follows:

<u>MULTIPLICAND</u>	<u>MULTIPLIER</u>	<u>RESULT TYPE</u>
integer	integer	integer
long integer	long integer	long integer
real	real	real
integer	long integer	long integer
integer	real	real
real	long integer	not allowed

Two examples of multiplication in expressions are:

```
writeln('two cubed = ', 2*2*2);
A := C * D
```

## The / Operator

The / operator is used for division and it always gives real results. The results of division operations are:

<u>DIVIDEND</u>	<u>DIVISOR</u>	<u>RESULT TYPE</u>
integer	integer	real
real	real	real
integer	real	real
real	integer	real
long integer	anything	not allowed
anything	long integer	not allowed

Example:

```
APPROXPI := 355 / 113; { APPROXPI is real }
```

## The DIV Operator

DIV is the integer division operator. It is used with integer and long integer operands with the following results:

<u>DIVIDEND</u>	<u>DIVISOR</u>	<u>RESULT TYPE</u>
integer	integer	integer
long integer	long integer	long integer
integer	long integer	long integer
long integer	integer	long integer
real	anything	not allowed
anything	real	not allowed

The DIV operation produces a result that is truncated toward  $\emptyset$ : the remainder of the division is lost. The expression

A DIV B

(where A and B are integer values) is equivalent to

TRUNC(A / B)

This shows the relationship between DIV and /.

## The MOD Operator

MOD takes two integer operands and returns an integer value that is the remainder of the absolute value of the first operand divided by the absolute value of the second operand.

A typical application of the MOD function is

A MOD B =  $\emptyset$

which is TRUE if B is a factor of A.



This implementation of the MOD operator does not correspond to the definition of MOD given by Jensen and Wirth.

## The + Operator

The + operator is used for addition of integers, long integers and reals. Results of addition operations are:

<u>OPERAND TYPES</u>		<u>RESULT TYPE</u>
integer	integer	integer
long integer	long integer	long integer
real	real	real
integer	long integer	long integer
integer	real	real
real	long integer	not allowed

Example:

XREAL := AINTEG + XREAL + 2;

The + operator can be used with a single operand as a sign indicator. This use of + produces a result that is identical to its operand.

## The - Operator

The - operator is used for subtractions of integer, long integer and real operands. Operations using the - operator give these results:

<u>MINUEND</u>	<u>SUBTRAHEND</u>	<u>RESULT TYPE</u>
integer	integer	integer
long integer	long integer	long integer
real	real	real
integer	long integer	long integer
long integer	integer	long integer
integer	real	real
real	integer	real
real	long integer	not allowed
long integer	real	not allowed

Example:

FRACTION := A / B - A DIV B; {A,B:integer, FRACTION:real}

The - operator can also be used with a single operand (integer, long integer, or real) to perform arithmetic negation, i.e. to change the sign of the operand. Examples of negation are:

-3  
-A  
-TRUNC(A)  
-(3 + 2)  
-(-2)



If a negated operand is used after one of the arithmetic multiplying operators (\*, /, DIV, or MOD) the operand must be enclosed in parentheses. Two examples are:

```
-A * (-B)
4 * (-OFFSET) MOD (-(3 + 2))
```

## The Relational Operators

The relational operators are used to make comparisons between scalar and/or real operands. They are especially useful with the flow of control statements which are explained in the next chapter. The relational operators are:

```
>      greater than
>=     greater or equal to
=      equal to
<      less than
<=     less than or equal to
<>     less than or greater than
```

Another relational operator, IN, is used with set values. It is explained in Chapter 7.

Comparisons are always made between two values of the same scalar or numeric type, and yield boolean results. If an integer is compared with a real, the integer is first converted to a real, and then a real-to-real comparison is done. Likewise, a comparison between an integer and a long integer will convert the integer to a long integer before invoking a long integer comparison. No other implicit type conversions are done by these operators; in general, a comparison that mixes types will be flagged by the Compiler. Boolean and user defined scalars may only be compared with values of the same type. Of course expressions may also be compared, provided that the comparison follows the rules described above. Here are some examples of properly used relational operators:

```
IF SCORES[I] > MAXSCORE THEN MAXSCORE := SCORES[I];
WHILE ANGLE < CIRCUMFERENCE / ARCLENGTH * 360 DO...;
REPEAT
...
UNTIL INDEX > LIMIT
```

Notice that relational operators, because they give boolean results, are a primary tool used to control program flow. The use of boolean values in IF, WHILE and REPEAT statements is explained in the next chapter.

User-defined scalars can be compared using any of the relational operators. The ordinality of a value of a user-defined scalar type is determined by its position in the type's declaration. Thus, with the declaration

```
VAR PAINT: (NONE, RED, ORANGE, YELLOW);
```

the statement

```
IF PAINT > NONE THEN PAINTPICTURE;
```

will cause the procedure PAINTPICTURE to be executed if the value of PAINT is RED, ORANGE, or YELLOW.

The result of comparing two real values will be exactly one of four possible relations:

- (1) equal,
- (2) less than,
- (3) greater than, or
- (4) unordered.

We are used to thinking that if two numbers are unequal, then one must be larger than the other. But the real type includes, in addition to numeric values, special diagnostic values that result from invalid operations and other special events (like division by zero). These diagnostic values may compare "unordered" with numeric values, and such comparisons may even cause runtime halts. See Appendix E for details; for ordinary programming just remember that, for real comparisons,

- "a <> b" [that is, a less than or greater than b] is not synonymous with "not (a = b)", and
- if "a < b" is false, you don't automatically know that "a >= b", because a and b may be unordered with respect to one another.

The relational operators can also be used to compare structured types. The operations permitted between operands of the structured types (arrays, sets, strings and records) are explained as each structured type is explained.

## Logical Operators

Sometimes you need to find a result that is dependent on more than one boolean value. In Pascal this capability is provided by the logical operators which, in order of precedence, are:

NOT	boolean negation
AND	boolean conjunction
OR	boolean disjunction

Logical operators take boolean operands and produce boolean results according to the following rules:

<u>A</u>	<u>B</u>	<u>A AND B</u>	<u>A OR B</u>	<u>NOT B</u>
TRUE	TRUE	TRUE	TRUE	FALSE
TRUE	FALSE	FALSE	TRUE	TRUE
FALSE	TRUE	FALSE	TRUE	FALSE
FALSE	FALSE	FALSE	FALSE	TRUE

As you can see the operator NOT takes a single boolean operand whereas the operators AND and OR both require two boolean operands.

Examples of correctly used logical operators are:

(A > B) AND (C < SQR(D)) {SQR(D) returns square of D}  
 A AND B AND NOT(A AND B) {result is always false}  
 (COUNT <= 100) OR ERROR {ERROR is a boolean variable}



Although it is not always necessary to evaluate both operands of a boolean expression in order to determine the result, a program may nevertheless evaluate both operands.

## Relational Operators with Boolean Operands

Each of the relational operators (=, <>, <=, <, >, >=, IN) yields a boolean value. Furthermore, the type boolean is defined such that FALSE < TRUE. Therefore, it is possible to define each of the 16 boolean operations using logical and relational operators. If p and q are boolean values, one can express

implication as p <= q  
 equivalence as p = q  
 exclusive OR as p <> q

Note that without the use of relational operators you would have to express the exclusive OR function as

(p AND NOT q) OR (NOT p AND q)

## Result Types

The result types for all combinations of operator and operands are described in full detail in the preceding sections. This section summarizes those descriptions.

In the table of results below, the column on the right lists the operators that may not be used with the pair of operands in that row.

<u>OPERAND TYPES</u>		<u>RESULT TYPE</u>	<u>ILLEGAL OPERATORS</u>
integer	integer	integer (real for / operator)	
long integer	long integer	long integer	/, MOD
real	real	real	DIV, MOD
integer	real	real	DIV, MOD
integer	long integer	long integer	/
real	long integer	not allowed	ALL

The logical operators NOT, AND and OR all take boolean operands and give boolean results. NOT precedes its single operand; AND and OR each take two operands.

The relational operators `>`, `>=`, `=`, `<=`, `<` and `<>` can be used to compare two boolean values, two user defined scalar values of the same type, or two numeric values. The only numeric values that cannot be compared are a real with a long integer. All relational operations yield boolean results.

## Assignments

There are also restrictions concerning what types of values may be assigned to what types of variables. The legal assignments for non-structured variables are:

<u>VARIABLE TYPE</u>		<u>EXPRESSION TYPE</u>
integer	:=	integer
long integer	:=	integer or long integer
real	:=	integer or real
boolean	:=	boolean
char	:=	char

To do assignments that are not shown in this table, use type conversion functions. These are described in Chapter 3.

5

## The Flow of Control

## Introduction

We begin with a brief digression on Pascal statements in general, since this chapter describes most of the types of statements. There are ten kinds of statements in Pascal; all are introduced in Chapter 2. Thus we have

### statement

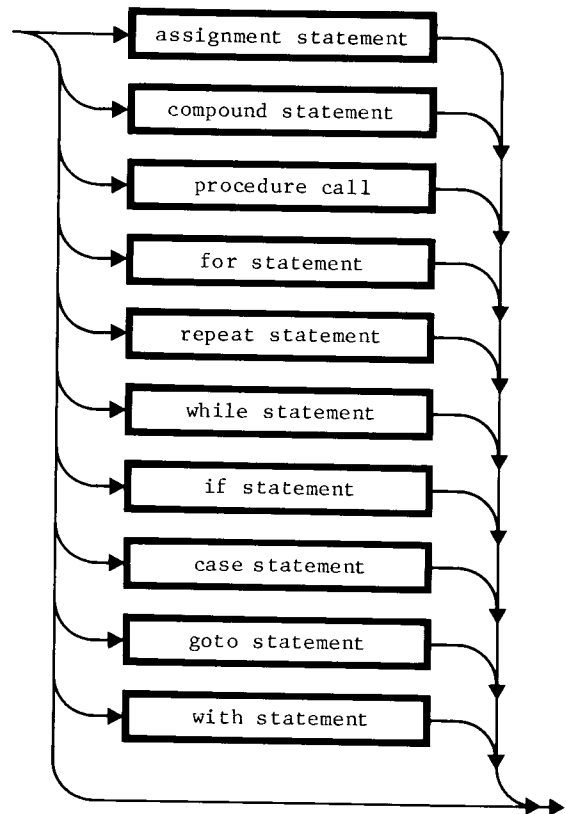

The assignment statement is described in Chapter 4. The WITH statement is described in Chapter 8.



Notice that technically, there is an eleventh type of statement which consists of nothing; this is called a "null statement." It simply means that whenever Pascal syntax calls for a statement, you can omit it.

It also means that when a program contains an unnecessary semicolon, the Pascal Compiler considers the semicolon to be separating a null statement from another statement. The result is two statements where you intend to have only one. Most of the time this is harmless, but occasionally it causes a compilation error because only one statement is allowed.

Except for the WITH and assignment statements, all the statements shown in the diagram are statements that determine the flow of control in a Pascal program; that is, they determine the order in which other statements are executed. There are "flow of control" statements that repetitively or conditionally execute other statements, and there are statements that transfer control to another portion of the program.

The flow of control statements can be subdivided into groups.

- The compound statement groups several statements into one.
- The procedure call statement causes execution of a procedure.
- The repetition statements (FOR, REPEAT and WHILE) allow a sequence of statements to be executed repeatedly.
- The conditional statements (IF and CASE) permit conditional execution of statements.
- The GOTO statement permits unconditional transfer of control from one part of the program to another.

## The Compound Statement

The compound statement is one of the most useful statements in Pascal. The syntax is

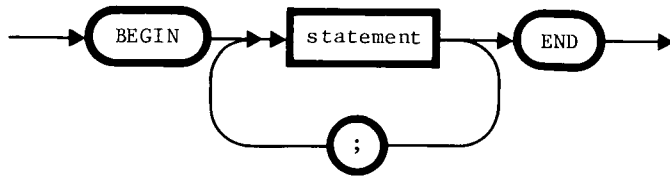
compound statement

A compound statement can contain any number of statements of any type, separated by semicolons. Note that the word BEGIN does not have a semicolon after it, since it is not a statement; likewise, there is no semicolon just before the word END because END is not a statement.

The compound statement is always considered as a single statement, even though it may contain more than one statement. Keep this in mind since most of the other flow of control statements act on single statements. Whenever you want a sequence of statements to be treated as a single statement, simply delimit it with BEGIN and END.

## The Procedure Call

A procedure is called by merely mentioning its name, with whatever parameters the procedure may require. The syntax for a procedure call is

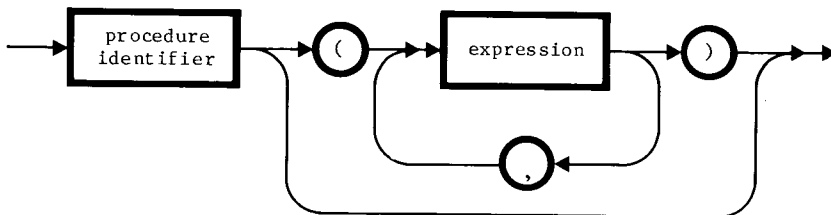
procedure call

The procedure identifier is the name of the procedure to be called. The list of expressions in parentheses is called the parameter list of the procedure call. The number of parameters in the list depends on the procedure being called.

The effect of a procedure call is to execute the procedure immediately (passing the specified parameters, if any). When the procedure terminates, control is transferred to the statement following the procedure call. See Chapter 6 for complete information on procedures.

## The Repetition Statements

Pascal has three statements that can repeatedly execute a statement or sequence of statements. Termination of the repetition is determined by the state of control variables or expressions. The repetition statements are the FOR, REPEAT and WHILE statements.

### The FOR Statement

The FOR statement is used to execute a statement a specific number of times. This is done by executing the statement once for each value of a control variable between an initial value and a limit value. The syntax of the FOR statement is

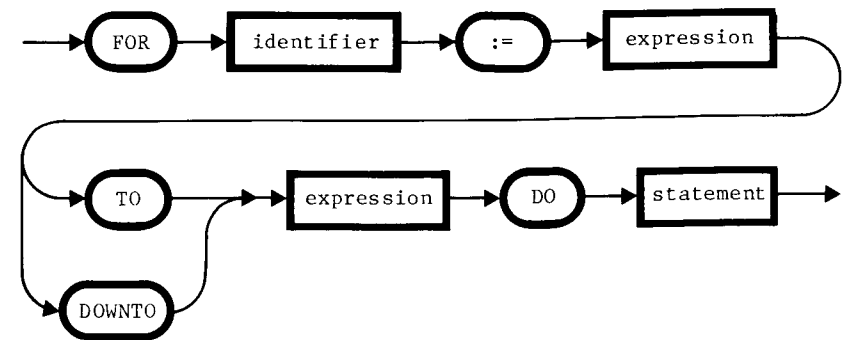
for statement

where the identifier is the identifier of a variable called the control variable. The control variable may be of any scalar type. The two expressions must be of the same scalar type as the control variable.



The control variable must be a simple variable; it cannot be an array element, a record field, or a dynamic variable.

The value of the "initial" expression is called the initial value, and the value of the "limit" expression is called the limit value.

For example, suppose that we have an array of 24 integer values and an integer value that can be used to index it:

```
VAR VAL: ARRAY [1..24] OF INTEGER;
    IX: INTEGER;
```

Now suppose that we want to multiply each value in the array by 2. We can do this with a FOR statement:

```
FOR IX := 1 TO 24 DO VAL[IX] := 2*VAL[IX]
```

Note that the control variable is available within the FOR statement. (Remember that the control variable, like any other variable, must be declared.) However, the value of the control variable should not be changed within the FOR statement.



If the value of the control variable is changed within the FOR statement, the results are unspecified as this is a violation of the rules of Standard Pascal.

In the above example, the embedded assignment statement is executed 24 times. Each time, the control variable (IX) takes on a new value; this value is 1 the first time and 24 the last time.

If we want to write out each value after multiplying by 2, we can use a compound statement inside the FOR statement:

```
FOR IX := 1 TO 24 DO BEGIN
    VAL[IX] := 2*VAL[IX];
    WRITELN(VAL[IX])
END
```

Processing of the FOR statement (using TO instead of DOWNTO) is as follows:

- First, the initial value is calculated (just once) and assigned to the control variable.

- Then, the limit value is calculated (just once).

- If the initial value is greater than the limit value, the remainder of the FOR statement is skipped. Otherwise, the following steps are taken:

1. The statement following the word DO is executed.
2. The control variable is assigned the value of its own successor.
3. If the new value of the control variable is not greater than the limit value, go back to Step 1 and repeat. Repetition continues until the value of the control variable is greater than the limit value.



After the FOR statement has finished executing, the value of the control variable is unspecified.

The DOWNTO option of the FOR statement sets the control variable to its own predecessor after each iteration, stopping when the value of the control variable is less than the limit value.

Some points to remember about Pascal FOR statements:

- A variable of any scalar type (integer, char, boolean, user-defined, or subrange) may be used as a control variable. However, a control variable of type real is not allowed.
- If the value of the control variable is changed within the FOR statement, the results are unspecified.
- Use of the control variable in either limit expression produces undefined results.

## The REPEAT Statement

The REPEAT statement, like the FOR statement, is used to control repetition in a program. The syntax is

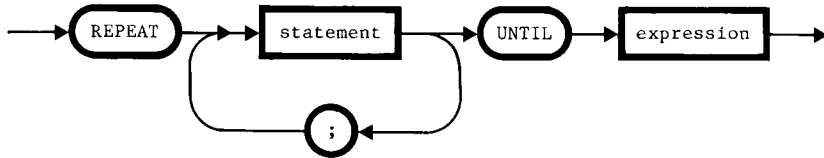
repeat statement

Note the differences from the FOR statement. The sequence of statements in a REPEAT statement doesn't need to be delimited by a BEGIN and an END; the REPEAT and UNTIL do this. The expression after UNTIL must have a boolean result. It is evaluated after each execution of the enclosed statements; hence the statements are always executed at least once. Notice that if the expression is never TRUE, the statements will be repeated forever.

A typical application of the REPEAT statement is

```
REPEAT
  WRITE('ENTER A NUMBER BETWEEN 0 AND 100 -> ');
  READLN(INTVAR);
  WRITELN('2 times ', INTVAR, ' is ', 2*INTVAR)
UNTIL (INTVAR < 0) OR (INTVAR > 100)
```

This REPEAT statement executes the contained statements until the user types a number less than 0 or greater than 100.

### The WHILE Statement

The WHILE statement is similar to the REPEAT statement. The syntax is

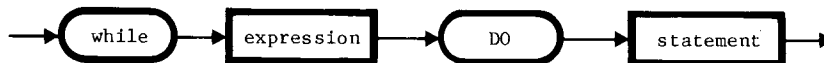
while statement

Unlike the REPEAT statement, the WHILE statement evaluates the controlling expression before each repetition of its statement.

If the expression, which must have a boolean result, is initially false, the statement will not be executed.

The WHILE statement acts on a single statement; thus a compound statement must be used if more than one statement is to be executed following the word DO.

For example, suppose that a program requires the user to type a number from 1 to 8. If the user does this, the program can continue. But if the user types a number that is out of range, the program must display an error message and give the user another chance; and this should be repeated until the user types a number in the required range. This is a natural application for the WHILE statement:

```
WRITE('Type a number from 1 to 8: ');
READLN(NUMBER);
WHILE (NUMBER < 1) OR (NUMBER > 8) DO BEGIN
  WRITELN('Number must not be less than 1 or more than 8!');
  WRITE('Try again. Type a number from 1 to 8: ');
  READLN(NUMBER)
END
```

If the user gives a correct response the first time, the WHILE statement is never executed. But if the user's response is out of range, the WHILE statement executes repeatedly until the user responds correctly. In either case, the value of NUMBER is guaranteed to be in the range 1..8 at the end of this sequence.

### The Conditional Statements

The IF statement and the CASE statement are used to execute a statement if a variable or expression has a desired value.

#### The IF Statement

The IF statement contains a boolean expression, a statement to be executed if the value of the expression is TRUE, and (optionally) another statement to be executed if the value of the expression is FALSE. The syntax of the IF statement is

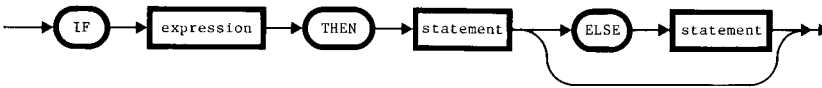
if statement

When an IF statement is executed, the following sequence of events takes place.

- The boolean expression is evaluated.
- If the boolean expression is TRUE:
  - The statement following THEN is executed.
- If the boolean expression is FALSE:
  - If there is an ELSE, the statement following ELSE is executed.
  - If there is no ELSE, the IF statement has no effect.

Note that just one statement is allowed after the word THEN; it may be a compound statement. Likewise, just one statement (possibly compound) is allowed after the word ELSE. Here is an example of an IF statement without an ELSE part:

```

IF TOTAL > 100 THEN BEGIN
    WRITELN('Error: Total too big');
    TOTAL := TOTAL - CRNT
END
  
```

If the value of the variable TOTAL is greater than 100, the compound statement is executed to display the message "Error: Total too big" and adjust the value of TOTAL; otherwise the compound statement is not executed.

The ELSE part of an IF statement is only executed if the result of the boolean expression is false. For example, the statement

```

IF TOTAL > 100 THEN BEGIN
    WRITELN('Error: Total too big');
    TOTAL := TOTAL - CRNT
END
ELSE WRITELN('Total is ', TOTAL)
  
```

will execute the compound statement if the value of TOTAL is greater than 100 (just as in the previous example); but if the value of TOTAL is not greater than 100, then the WRITELN statement following the word ELSE is executed to display the message "Total is " followed by the value of TOTAL.



It is important to be careful of semicolon placement in IF statements. For example

```

IF A = B THEN BEGIN
    WRITELN('A equals B');
    EQCOUNT := EQCOUNT + 1
END
ELSE WRITELN('A not equal to B')
  
```

is correct: there is no semicolon after the END because the ELSE does not start a new statement--it is a continuation of the same IF statement. A common mistake is to put a semicolon before the ELSE, which causes a compilation error because there is no Pascal statement that begins with the word ELSE.

### Nested IF Statements

The statement following the word ELSE can be an IF statement, and can contain its own ELSE clause. Thus a statement can be written to take different actions for each of several mutually exclusive conditions.

```

REPEAT
    WRITE('Enter command S,D,P,Q,E -> ');
    READLN(COMM);
    IF COMM = 'S' THEN SHUFFLEDECK
    ELSE IF COMM = 'D' THEN DEALCARDS
    ELSE IF COMM = 'P' THEN DISPLAYPOINTS
    ELSE IF (COMM = 'Q') OR (COMM = 'E') THEN QUIT
UNTIL (COMM='Q') OR (COMM='E')
  
```

Conditions will only be checked until a true one is found. The greatest efficiency is achieved if the most probable conditions are checked first.

The statement following the word THEN can also be a nested IF statement, but this construction is less useful and can lead to a confusing program. Be careful with the following type of



construction:

```
IF A=B THEN IF C=D THEN WRITELN('A=B and C=D')
             ELSE WRITELN('A=B but C<>D')
```

The ELSE matches the last preceding THEN, as indicated by the indentation. If you add another ELSE it will match the first THEN:

```
IF A=B THEN IF C=D THEN WRITELN('A=B and C=D')
             ELSE WRITELN('A=B but C<>D')
             ELSE WRITELN('A<>B')
```

The above statement can be clarified, without changing its meaning, by making the nested statement a compound statement:

```
IF A=B THEN BEGIN
             IF C=D THEN WRITELN('A=B and C=D')
             ELSE WRITELN('A=B but C<>D')
             END
             ELSE WRITELN('A<>B')
```

Now it is obvious which ELSE matches which THEN.

## The CASE Statement

The CASE statement uses the value of an expression to select and execute one statement from a list of statements. The controlling expression and the list of statements are contained within the CASE statements, and each statement in the list is "labeled" with one or more constants called case selectors which are possible values of the controlling expression. An OTHERWISE clause is optional; if present, it contains a statement which is executed if the controlling expression's value does not match any of the case selectors.

The syntax is

case statement

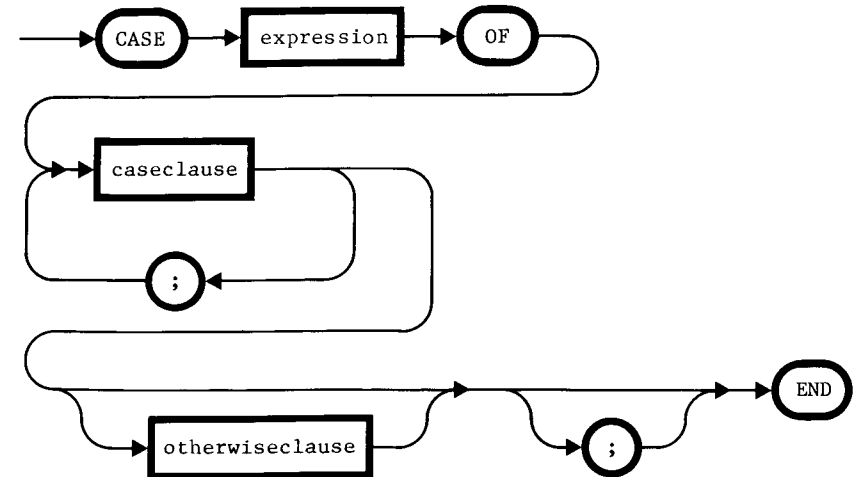

caseclause

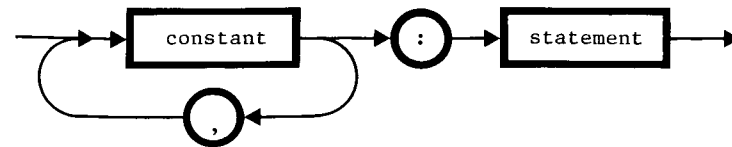

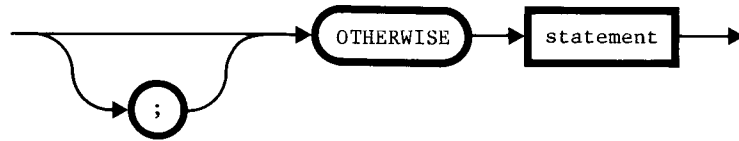
otherwiseclause

where the expression must give a result of a scalar type, and the constants in each caseclause must be of the same type. The expression is evaluated and the result is sequentially compared with the constants in each caseclause. If the result matches one of the constants, only the statement in that caseclause is executed.

If no match is found and there is an OTHERWISE clause, the statement in the OTHERWISE clause is executed. If no match is found and there is no OTHERWISE clause, then the CASE statement has no effect.

In discussing nested IF statements above, we gave the following example:

```
REPEAT
  WRITE('Enter command S,D,P,Q,E -> ');
  READLN(COMM);
  IF COMM = 'S' THEN SHUFFLEDECK
  ELSE IF COMM = 'D' THEN DEALCARDS
  ELSE IF COMM = 'P' THEN DISPLAYPOINTS
  ELSE IF (COMM = 'Q') OR (COMM = 'E') THEN QUIT
UNTIL (COMM='Q') OR (COMM='E')
```

Exactly the same effect can be achieved more naturally with a CASE statement:

```
REPEAT
  WRITE('Enter command S,D,P,Q,E -> ');
  READLN(COMM);
  CASE COMM OF
    'S': SHUFFLEDECK;
    'D': DEALCARDS;
    'P': DISPLAYPOINTS;
    'Q', 'E': QUIT
  END
UNTIL (COMM='Q') OR (COMM='E')
```

If we used the nested IF statement and tried to allow for the possibility of lower-case letters, the resulting nest would be unwieldy. With a CASE statement, however, the enhancement is easy. We also add an OTHERWISE clause to handle invalid command input by calling a procedure named HELP.

```
REPEAT
  WRITE('Enter command S,D,P,Q,E -> ');
  READLN(COMM);
  CASE COMM OF
    'S', 's': SHUFFLEDECK;
    'D', 'd': DEALCARDS;
    'P', 'p': DISPLAYPOINTS;
    'Q', 'E', 'q', 'e': QUIT
    OTHERWISE HELP
  END
UNTIL (COMM='Q') OR (COMM='E') OR (COMM='q') OR (COMM='e')
```

As in all other cases where only a single statement is allowed, each statement within a caseclause or OTHERWISE clause can be a compound statement.



Caution is required if you use integer constants as case selectors in a CASE statement. If the difference between the largest and the smallest case selector in a CASE statement is too great, the Compiler will be unable to compile it. The limit depends on the statements within the CASE statement, but as a rule of thumb do not use any integer case selectors that differ by more than 1000.

The reason for this is that to implement a CASE statement, the Compiler builds a table in the code with an entry for each possible case selector from the smallest actually used to the largest.

## The EXIT and HALT Procedures

The Pascal statements already described should be adequate for controlling the flow of almost all programs. In some cases, it is convenient to be able to exit immediately. The EXIT procedure allows this; the syntax for calling EXIT is

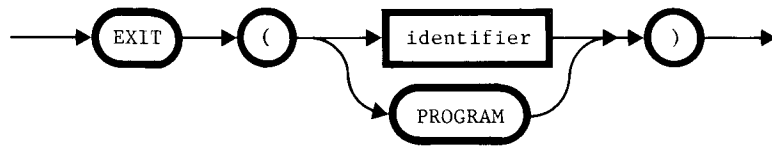

where the identifier is the name of a procedure, a function, or the program. The most common use of EXIT is with either the word PROGRAM or the program name as the parameter; EXIT then terminates the program in an orderly manner: all open files are closed (see Chapter 10), and control returns to the command level of the system just as if the program had reached its END.

When a procedure or function identifier is used in calling EXIT, the specified procedure or function is exited.



Do not use this technique unless you are sure you understand what you are doing (Chapter 6 covers procedures and functions).

Control returns to the point where the procedure or function was called, just as if the procedure or function had reached its END; however, if a function is exited without an assignment being made to the function identifier, the function will return an unpredictable value.

Note that the specified procedure or function need not be the one in which the EXIT procedure is called. EXIT follows the trail of procedure calls back to the procedure or function specified; each procedure or function in the trail is exited (whether or not it has completed its execution). If the specified procedure or

function is recursive (see Chapter 6), then the most recent incarnation is exited; earlier incarnations will complete their executions normally.

The HALT procedure takes no parameters. It brings the program to an immediate halt with a non-fatal run-time error.

## The GOTO Statement

Some programming situations demand an instant transfer of control in a manner that is not easy to achieve using the repetition or conditional statements. To handle these situations Pascal has the GOTO statement. The GOTO statement should be used only in those unusual cases that cannot be handled easily by the other control statements. By default, the Compiler does not allow GOTO statements. If your program uses GOTO statements you must include the Compiler option

```
{GOTO+}
```

This option must precede the first GOTO statement in the program. Please see Appendix F for more information about Compiler options.

The GOTO statement causes a direct transfer of control to a labeled statement that is in the same procedure or function as the GOTO statement (considering the main program to be a procedure). The extremely uncomplicated syntax of GOTO is

goto statement

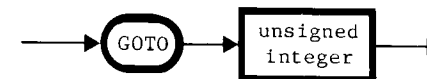

where the label is an unsigned integer of not more than four digits. The label must first be declared. Label declarations come immediately after the heading of a program, procedure, or function, before any other declarations. The following program, which loops infinitely, shows legal use of label declarations and

the GOTO statement. It also shows some of the problems of the GOTO statement.

```
{GOTO+}
PROGRAM JUMP;
LABEL 1, 5326, 42, 999;
BEGIN
  1: GOTO 5326;
  999: GOTO 42;
  5326: GOTO 999;
  42: GOTO 1
END.
```



Note that you cannot jump out of a block with a GOTO statement.

Passing control to a statement that is inside a structured statement from a point outside the structured statement by means of a GOTO has undefined effects, although the Compiler will not indicate an error. All of the GOTO statements in the following example are wrong for this reason.

```
IF TRUE THEN
  123: GOTO 6;
FOR INDEX := 1 TO 10 DO
  6: GOTO 123;
BEGIN
  1: WRITELN('GOTO ANOTHER PROCEDURE');
  GOTO 6
END;
GOTO 1
```

## 6

## Procedures and Functions

## Introduction

Procedures and functions are the subroutines of Pascal. Each procedure or function is a distinct section of code, contained within a program, that is executed when the program calls it. In many cases the program calls it more than once.

A procedure can be thought of as a subprogram nested in the main program (or within another procedure, or within a function). Just as you define a Pascal program by writing it in text form, you define a procedure by writing a procedure definition into the text of the program. If you study the syntax diagrams further on in this chapter you can see that a procedure definition, like a program, contains one block. The block may contain other procedure definitions. Thus procedures (and functions) can be freely nested within each other. Indeed, for purposes of program execution the system considers the program itself to be just the outermost procedure of a nested structure of procedures and functions.

A procedure is called by means of a procedure call statement, which refers to the procedure by name and supplies values for any parameters belonging to the procedure. Parameters are a special kind of variable used to pass information to the procedure when it is called; they are discussed in detail below.

A function is similar to a procedure except that it is called by means of a function reference instead of a call statement. The function reference appears in an expression; it references the function by name and supplies any parameters required by the function. The function returns a value; that is, it computes a value, and this value replaces the function reference when the expression is evaluated.

Procedures and functions are defined (written) after the variable declarations, if any, and before the compound statement that contains the statements of the program.

## Defining a Procedure

A procedure definition consists of a procedure heading, a block, and a terminating semicolon:

procedure definition

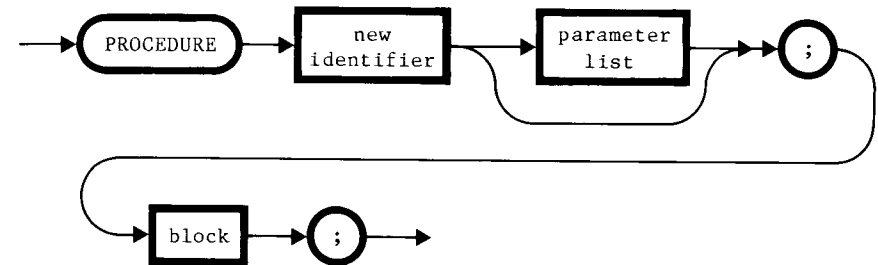

The first part of the procedure definition--the word PROCEDURE, the identifier, the parameter list, and the semicolon--are called the procedure heading. The remaining part--the block and the final semicolon--are called the procedure body. The syntax for a parameter list is

parameter list

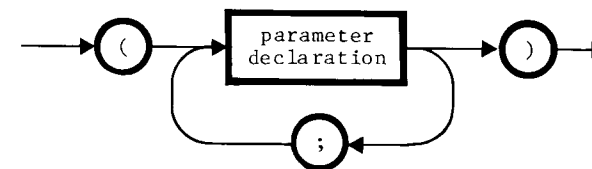

The parameter list declares the procedure's parameters, if any. It consists of an opening parenthesis, one or more parameter declarations separated by semicolons, and a closing parenthesis. The syntax for each parameter declaration is

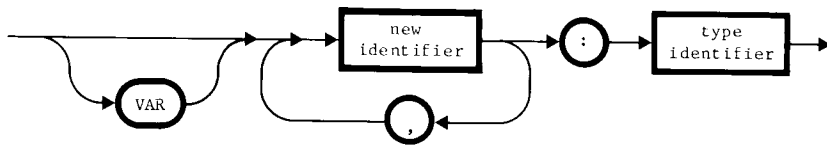
parameter declaration

If the word VAR is used, this declaration declares one or more variable parameters; otherwise it declares one or more value parameters. The distinction is explained below. Each declaration can declare any number of parameters, all of the same type. Note that the type must be given as a single identifier such as REAL, CHAR, or the identifier of type that has been declared in the program. This is one of the reasons for declaring types.

Here is an example of a simple procedure heading that declares three value parameters:

```
PROCEDURE ALPHA (INITIAL, LIMIT: REAL; COUNT: INTEGER);
```

INITIAL and LIMIT are real parameters, and COUNT is an integer parameter. The following example declares a variable parameter and a value parameter:

```
PROCEDURE BETA (VAR ERRFLAG: BOOLEAN; N: INTEGER);
```

ERRFLAG is a variable parameter of type boolean, and N is a value parameter of type integer.

The rest of a procedure definition consists of one block. The syntax for a block is

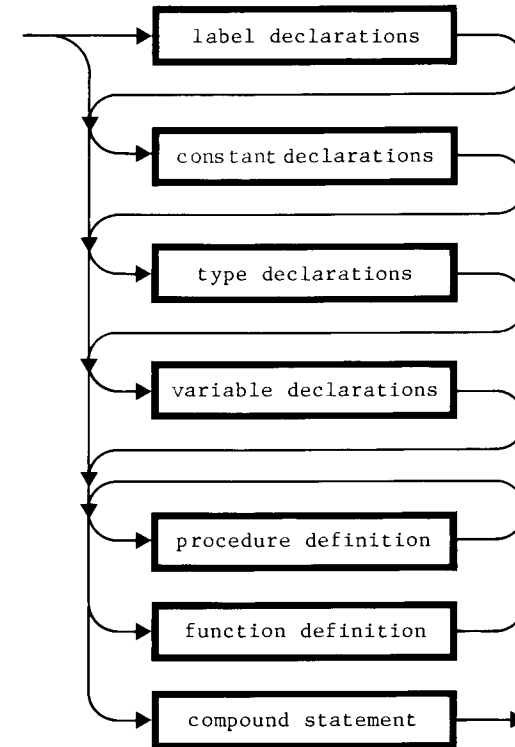
block

In other words, a block consists of optional declarations, optional procedure and function definitions, and one compound statement. Further on in this chapter we will see a special case where the block is replaced by the word FORWARD.

## **Value Parameters**

There are two kinds of parameters: value parameters and variable parameters. Every parameter is a value parameter unless it is explicitly declared as a variable parameter (see next section). Value parameters are used to pass values (of expressions or variables) to a procedure or function at the time it is called.

The following example shows how value parameters can be used:

```
PROCEDURE WRITEMEAN (A, B: REAL);
  {Display the mean of two real values}
  VAR SUM: REAL;
  BEGIN
    SUM := A + B;
    WRITELN(SUM/2) {Display the value on the screen}
  END;
```

WRITEMEAN has two formal parameters, A and B; both are value parameters of type real. A and B are, in effect, real variables belonging to the WRITEMEAN procedure; but they have the special property that each time the procedure is called, A and B are initialized with the values of actual parameters contained in the call statement. The call statement must provide an actual parameter for each formal parameter.

The actual parameters are expressions. Each expression is evaluated and the result is assigned to the corresponding formal parameter before the statements of WRITEMEAN are executed.

All of the following are valid calls to WRITEMEAN (with different results):

```
WRITEMEAN(4.3, X);
WRITEMEAN(X, Y);
WRITEMEAN(Z + 2.3*Y, X);
WRITEMEAN(25, Z)
```

In these procedure calls, assume that X, Y, and Z are variables or constants of type real. Note that each actual parameter in the procedure call is an expression; the expression is evaluated and the value is passed to the procedure. The fourth example shows that an integer value may be supplied for a real parameter; the integer value is converted to a real value just as if it were being assigned to a real variable.



The type of a value parameter can be any Pascal data type except a file type. To pass a file to a procedure or function, you must use a variable parameter (see next section).

## Variable Parameters

A value parameter, as we have seen, provides one-way communication between the calling program and the procedure or function: the call supplies a value, and this value is used inside the procedure or function. A variable parameter provides two-way communication.

With a variable parameter, the actual parameter is not an expression but a variable reference, and the information passed to the procedure or function is not the value of the variable but the variable itself. Note that this variable is one declared outside the procedure or function.

(At run time, what is passed is the address of the actual parameter, so that the code of the procedure or function can access it.)

If the value of the formal parameter is changed inside the procedure or function, the effect is to change the value of the actual parameter variable (outside the procedure or function). The declaration of the formal parameter is preceded by the reserved word VAR, as in the following example:

```
PROCEDURE MOVIT (RHO, THETA: REAL; VAR X, Y: REAL);
  {Update rectangular coordinates X and Y for motion
   through distance RHO at angle THETA (in degrees).}
  CONST PI = 3.14159;
  BEGIN
    THETA := THETA*PI/180;           {Convert to radians}
    X := X + (RHO * COS(THETA));
    Y := Y + (RHO * SIN(THETA))
  END;
```

COS and SIN are trig functions contained in the system library (see Appendix A). They assume that angles are given in radians. The MOVIT procedure has two value parameters, RHO and THETA, and two variable parameters, X and Y. Suppose that MOVIT is called by the statement

```
MOVIT(RADIUS, ANGLE, HORIZ, VERT)
```

where RADIUS, ANGLE, HORIZ, and VERT are real variables. MOVIT

assigns the current values of RADIUS and ANGLE to its own value parameters RHO and THETA, respectively. It also assigns the current values of HORIZ and VERT to X and Y respectively.

When MOVIT executes, it converts the value of THETA to radians without affecting the variable ANGLE. But when it changes the values of X and Y, it changes the values of HORIZ and VERT. Because MOVIT was called with HORIZ and VERT as actual parameters for the formal variable parameters X and Y, each reference to X during this execution of MOVIT is in effect a reference to HORIZ; and each reference to Y is in effect a reference to VERT.

Of course, MOVIT could have been written with direct reference to HORIZ and VERT, instead of X and Y. But that would make it less flexible; by using variable parameters, MOVIT is able to update any two real variables that are passed to it.

The type of a variable parameter can be any data type, including file types. If you have a formal parameter that is a string, you can pass any string variable to it, even if the declared length is not the same. However, if the length of the source parameter is less than the length of the formal parameter, you must use the VARSTRING Compiler option, which is described in Appendix F.

 However, an individual element of a packed variable cannot be supplied as the actual parameter (see Chapters 7 and 8 for discussion of packed variables).

 For special purposes, there are two data types called BYTESTREAM and WORDSTREAM which are used for variable parameters. Chapter 13 describes these types.

## Defining a Function

Syntactically, a function definition is very similar to a procedure definition. The heading has the word FUNCTION instead of PROCEDURE, and it specifies a type, which is the type of the value returned by the function.

### function definition

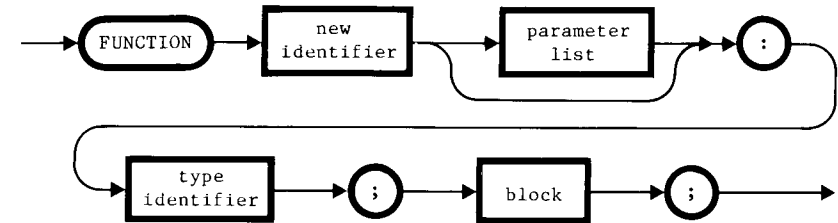

The type of the function must be a simple type (real, scalar, subrange, or pointer).

Within the function, there should be an assignment statement that has the function identifier on the left-hand side. This is how the function returns a value. For example, consider the WRITEMEAN procedure shown earlier. It displays a result on the screen. For some programs, it would be more useful to define a function which would perform the same calculation and return the result:

```

FUNCTION MEAN (A, B: REAL): REAL;
  {Return the mean of two real values}
  VAR SUM: REAL;
  BEGIN
    SUM := A + B;
    MEAN := SUM/2
  END;
  
```

If no value is assigned to the function identifier, an undefined value will be returned. If there are two or more assignment statements with the function identifier on the left-hand side, the last value assigned as the function executes is the value returned.

 Normally the function identifier should be used within the function only as shown in the example above: on the left side of an assignment statement, for the purpose of returning a value. Do not use the function identifier on the right-hand side of an assignment statement within the function, unless the function is designed to be recursive. Recursive functions and procedures are discussed further on.



## Calling a Function

As mentioned in Chapter 2, a function is activated by a function call, which appears as an operand in an expression. When the operand is evaluated at run time, the function is executed. The value returned by the function becomes the value of the operand. The syntax of a function call is

function call

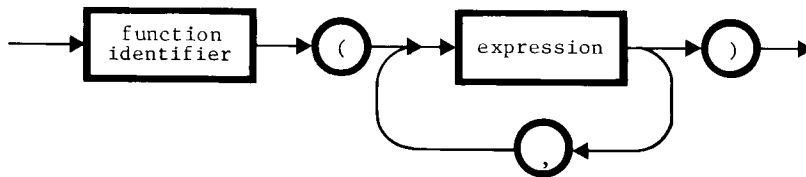

## Recursion

A recursive procedure or function is one that calls itself; this is permitted in all Pascal procedures and functions. A full discussion of the idea of recursion is beyond the scope of this manual; instead a single example is offered as an illustration.

Consider the following situation: A 30x50 array of boolean values is used to represent a graphic picture 30 dots high and 50 dots wide. Each boolean value represents a dot in the picture--TRUE for a white dot and FALSE for a black dot. The array is declared as follows:

```
VAR PIC: ARRAY[1..30, 1..50] OF BOOLEAN;
```

Now suppose that the picture contains several "images," each of which consists of a group of white dots that are connected to each other--that is, every dot in an image is a neighbor of at

least one other dot in the image (horizontally, vertically, or diagonally). In terms of the array, this means that an image is a collection of TRUE elements, and each of these elements is a neighbor of at least one other element in the image. One array element is a neighbor of another if their indices differ by 1 or 0, and both have the value TRUE.

The problem is this: we want to write a procedure called ZAP that will erase all the dots in one image, if we give it the coordinates (indices) of any one dot in the image--without affecting any other image in the picture. This is an unwieldy problem if ZAP has to find all the dots in the image in a single pass; but if ZAP can call itself, the problem becomes simple. In English, the ZAP procedure is

```
"IF the specified dot is in the array AND it is white,
  THEN erase it and ZAP each of its neighbors in turn.
  ELSE do nothing and return immediately."
```

When ZAP is called once with the indices of a dot in an image, it will eventually call itself for every other dot in the image. To write ZAP in Pascal, we first write a convenient function for checking that a pair of indices is valid--i.e., that both indices are within the bounds of the array PIC:

```
FUNCTION INARRAY(I, J: INTEGER): BOOLEAN;
BEGIN
  INARRAY := (I IN [1..30])
    AND
    (J IN [1..50])
END;
```

The reference INARRAY(A, B), where A and B are integer values, will return TRUE if A and B are both valid indices for PIC. Now we can write ZAP as follows:

```

PROCEDURE ZAP(X,Y: INTEGER);
  {Two variables to be used as coordinates of neighbors: }
  VAR XN, YN: INTEGER;
  BEGIN
    {If X,Y is in the array and is a white dot... }
    IF INARRAY(X,Y) THEN IF PIC[X,Y] THEN BEGIN
      {...then erase it... }
      PIC[X,Y] := FALSE;
      {...and ZAP all its neighbors: }
      FOR XN := X-1 TO X+1 DO
        FOR YN := Y-1 TO Y+1 DO
          ZAP(XN,YN)
        END
      END
    END;
  END;

```

(Notice that in the process of ZAPping all the neighbors, ZAP will also ZAP the dot that it started with. This is harmless, because the dot is no longer white; this particular recursive call will do nothing and return immediately.)

Each time a recursive routine calls itself, a new "incarnation" of the routine is created--that is, all the data belonging to the current incarnation has to be saved and new space allocated for the data belonging to the new incarnation. Eventually, if the routine is written correctly, the recursion terminates; the last incarnation does not call itself, but simply returns to the previous incarnation, which returns to the one before it, and so forth. Finally the first incarnation returns, and the execution of the recursive routine is finished.

In the case of ZAP, each incarnation makes 9 recursive calls in sequence. Each of these calls starts a new chain of incarnations. Each chain terminates when the dot that it is supposed to ZAP turns out not to be in the array, or not to be a white dot. When all the dots in the image have been erased, then all the chains have terminated and all the incarnations have returned; the original incarnation returns to the point in the program where ZAP was called non-recursively.

## Termination

In order to make sense, a recursive function or procedure has to be written so that it will always terminate. This means that there is some condition under which it will not call itself; furthermore, if it calls itself enough times, it will always arrive at that condition. Otherwise, it may keep calling itself

until the system runs out of space to keep track of all the recursive calls, and halts the program with a "Stack overflow" error message. Actually this can happen even if the recursive procedure or function is correctly written, because of the space required by the numerous incarnations. When this happens, some sort of rewriting is required. A full discussion of space-saving techniques is beyond the scope of this manual, but the following suggestions may prove helpful:

- Eliminate the recursion, or find a way to make it terminate sooner.
- Reduce the amount of storage used for variables inside the recursive routine, since this storage has to be replicated for each recursive call.
- Segment your program to increase the amount of space available at the point where the recursive routine is called (see Chapters 14 and 15).
- If the program uses dynamic variables, use the MARK and RELEASE procedures to increase the amount of space available at the point where the recursive routine is called (see Chapter 9).
- Use files to store large data structures on diskette instead of in memory (see Chapters 10, 11, and 12).

## Indirect Recursion

The above discussion describes direct recursion; there is also such a thing as indirect recursion. Suppose that a program contains three or more procedures or functions called A, B, C, and so forth. If A calls B and B calls A, that is indirect recursion. Likewise, if A calls B, B calls C, and C calls A, we have indirect recursion. The most general definition of recursion is that it occurs whenever a procedure or function is called (by itself or by another procedure or function) before it completes its execution and returns.

Like direct recursion, indirect recursion requires that there be a condition that will terminate the recursion, and the procedures must be designed to guarantee that the termination condition will be reached.

When you write indirectly recursive procedures or functions, one procedure or function must call another before it is defined. This is impossible using normal procedure or function definitions, so Pascal provides a special form of definition called the forward definition. In a forward definition the block is replaced by the word FORWARD. The forward definition suffices to declare the identifier and parameters, and the type in the case of a function definition. The forward-defined procedure or function can then be called in a following procedure or function, and then the remainder of the forward definition can be given as in the following example (where function F calls procedure P and vice versa):

```
{Forward definition of F, to allow it to be referenced
within P:}
FUNCTION F (X, Y: REAL; COUNT: INTEGER): REAL;
  FORWARD;
```

```
{Normal definition of P, which calls F:}
PROCEDURE P (N: INTEGER);
  VAR A, B, C: REAL;
  BEGIN
    ... {Various statements}
    C := 2 * F(A, B, N) {This calls F}
    ... {Various statements}
  END;
```

```
{Continued definition of F; parameters and type omitted
since they are already declared:}
FUNCTION F;
  VAR TMP, DL, DX, DY: REAL;
  BEGIN
    ... {Various statements}
    P(TRUNC(X)) {This calls P}
    ... {Various statements}
  END;
```

## Rules of Scope

Up to this point we have informally talked about a variable "belonging to" a particular procedure or function, or to the main program. What this means is that the procedure, function, or program knows what the identifier means because it contains the declaration.

Now we will give the formal rules for the scope of any object that has an identifier. The scope of an object is that part of the total program in which the object is known by its identifier. The rules of scope are simple, and they apply universally to declared constants, declared types, variables, procedures, and functions.

In this section the word "procedure" will be used loosely, to mean any procedure, any function, or the main program. Also the word "declaration" will be used to include procedure and function definitions. We can then view any program as a structure of nested procedures. The main program itself is the outermost procedure, and may have procedures nesting within it; these nested procedures may have other procedures nested within them. The "extent" of a procedure is the entire procedure, including the heading and any procedures nested within it.

The rules of scope are:

- An identifier that has been used in a declaration in a particular procedure can be redeclared in any other procedure, including procedures nested within the first procedure.
- The scope of a declared object is the entire extent of the procedure in which it is declared, minus the entire extent of any nested procedure in which the same identifier is redeclared.
- The above rules apply to formal parameters, just as they apply to other variables declared in a procedure.

To see how this works, consider the program structure shown below, where Procedures A and B are nested within Program P, and Procedure Z is nested within Procedure B:

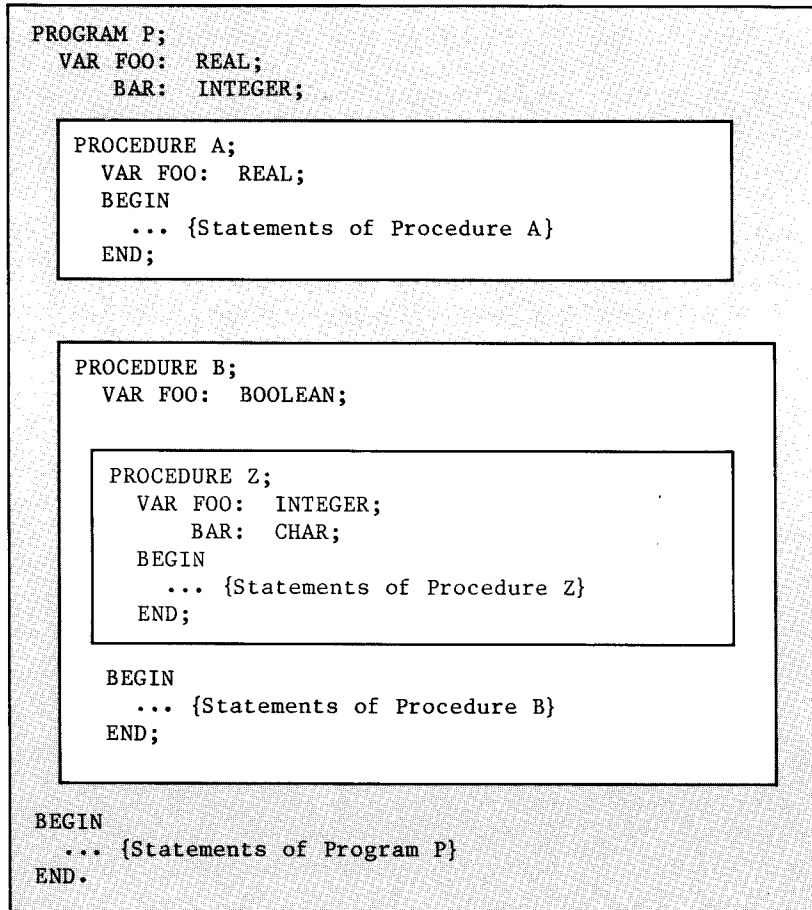

The identifiers FOO and BAR are declared and redeclared at various points in the program. What is the scope of each variable shown in the diagram?

- The real variable FOO declared in the main program is known throughout the main program, except that it is not known anywhere within Procedure A or Procedure B

since the identifier FOO is redeclared in those procedures.

- The integer variable BAR declared in the main program is known throughout the main program, except that it is not known anywhere within Procedure Z since the identifier BAR is redeclared in that procedure.
- The real variable FOO declared in Procedure A is known throughout Procedure A.
- The boolean variable FOO declared in Procedure B is known throughout Procedure B, except that it is not known anywhere within Procedure Z since the identifier FOO is redeclared in that procedure.
- The integer variable FOO and the char variable BAR declared in Procedure Z are known throughout Procedure Z.

A declared object is said to be local to the procedure in which it is declared, and global to any nested procedure that is within its scope. Thus each procedure knows about its own local objects, and also about global objects. The nested structure of Pascal, and the rules of scope, are what make it a block-structured language. The virtues of block structure, and the techniques for taking advantage of it, are beyond the scope of this manual; however, any good tutorial on Pascal goes into this topic at some length.

Built-in objects (the built-in types, procedures, functions, etc.) act as if they were declared in a procedure that the main program is nested in. Thus they are global to the main program, unless they are redeclared. Values of variables local to a procedure are lost upon exit from the procedure.

## Segment Procedures and Functions

A segment procedure or function is declared by placing the word SEGMENT at the beginning of the heading. For example,

```
SEGMENT FUNCTION CALCULATE (X, Y, Z: REAL): REAL;
```

is a function heading for a segment function named CALCULATE. The rest of the definition is conventional. The effect of making the function a segment is that at run time, the code of the function is not loaded into memory until the function is called; as soon as it terminates, the space occupied by the code is released and can be used for something else—such as the code of another segment function or procedure. This is helpful with programs that contain large procedures or functions; see Chapter 15 for more information.

Segment procedures and functions are called in the same way as ordinary procedures and functions.

## **External Procedures and Functions**

An external procedure or function is written in assembly language as a .PROC or .FUNC. The assembled code is assumed to be in a library file, which will be linked into the compiled Pascal program before execution; the Program Preparation Tools manual describes the use of the Assembler and Linker. Within the Pascal program, the external procedure or function must still be defined so that it can be called. The external procedure or function definition consists of a conventional heading, with the word EXTERNAL instead of a block. For example,

```
PROCEDURE MAKESCREEN (INDEX: INTEGER);
EXTERNAL;
```

This means that the procedure MAKESCREEN is an external assembly-language procedure, with one parameter of type integer. It is the user's responsibility to make sure that the assembly-language procedure or function is compatible with the external declaration in the Pascal program; the Linker checks only that the parameters occupy the correct number of bytes.



There is a special rule for external procedures and functions: a variable parameter can be declared without any type.

## **Size and Complexity Limits**

The Compiler imposes limits on the size and complexity of procedures. Here the term "procedure" includes functions and the main program. The "size" is the number of bytes of memory required for the compiled code of the procedure; "complexity" has to do with the number of backward jumps in the compiled code.

The Compiler error message "Procedure too long" means either that the procedure's code exceeds the limit of about 1200 bytes, or that the procedure has too much complexity. In either case, the remedy is simple: move some statements from the offending procedure into one or more new procedures, and call the new procedure(s) at the point where the statements originally appeared. The new procedure(s) may be nested within the original procedure, so that the essential structure of the procedure is not changed.

By examining the source text of a procedure you cannot tell whether it will violate the limits, since the limits apply to the code created by the Compiler, not to the source text. But as a rule of thumb, a procedure whose body can be printed on one page will compile successfully. (Nested procedures don't count.) In any case it is good programming practice to keep procedures short; it makes the program much easier to understand and maintain.

---

**7**

**Arrays, Sets, and Strings**

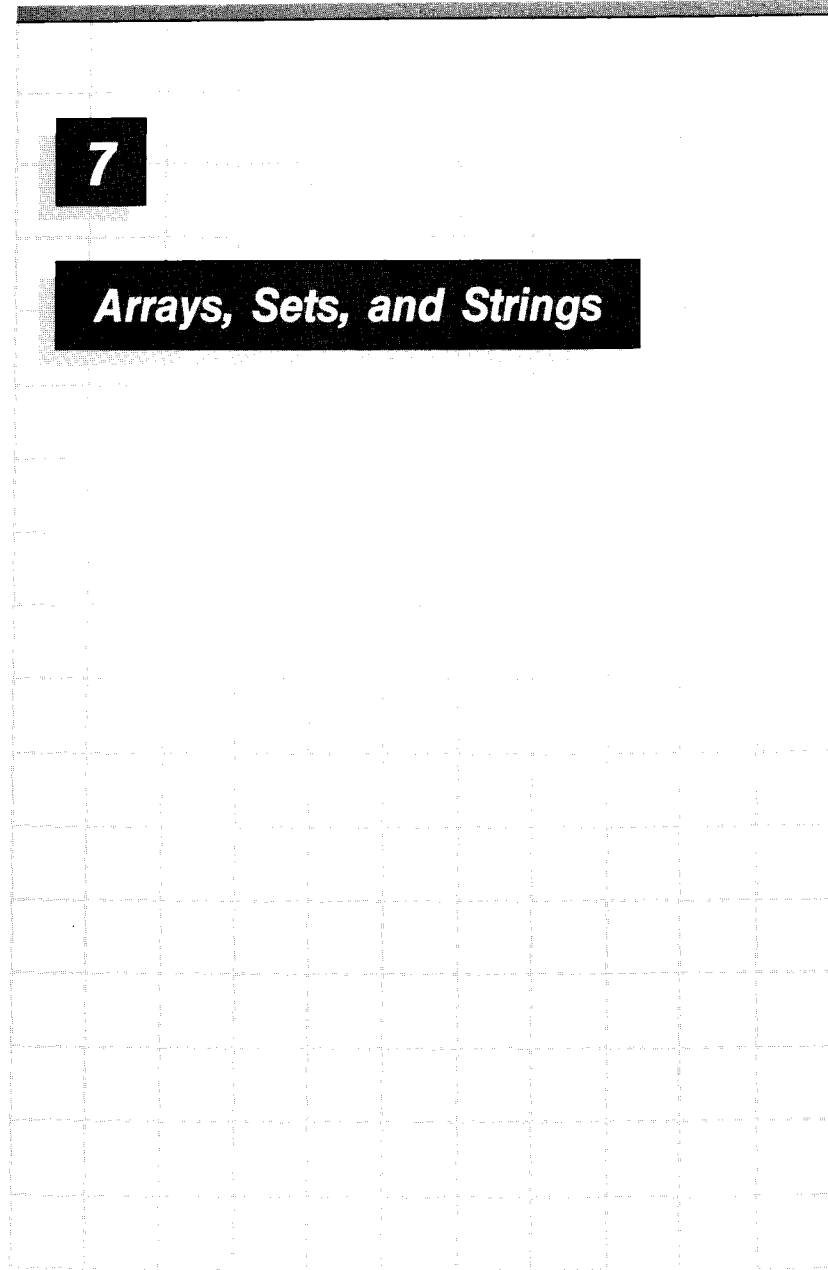

## Introduction

Up to this point, all the data types discussed have been simple data types, which have single values. Pascal also has a variety of structured data types, which can be thought of as collections of values. This chapter covers only the three simplest kinds: arrays, sets, and strings. Subsequent chapters cover records and files.

An array variable is a collection of variables called elements; all the elements of an array are of the same type. A single element of the array is referenced by using the array identifier with an index value (sometimes called a subscript). The index value selects the desired element from among the other elements of the array.

A set is a collection of values which are called members of the set. Set operations in Pascal are fast, and allow very straightforward coding of routines which would be much more complicated without the use of sets.

A string is a sequence of characters, normally treated as a single entity. Apple III Pascal provides a set of built-in procedures and functions for manipulating strings.

## Array Variables

An array variable is an ordered collection of elements, all of the same type. Each element in an array can be considered as a variable in its own right. A particular element is distinguished from other elements by means of an index value enclosed in square brackets. For example, you can declare an array called XYZ, consisting of three elements of type real numbered 1, 2, and 3, as follows:

```
VAR XYZ: ARRAY [1..3] OF REAL;
```

Then these elements can be referred to individually as XYZ[1], XYZ[2], and XYZ[3]. Each of them is a variable of type real.

Pascal arrays differ from arrays in other languages in several ways:

- Pascal arrays can have any number of dimensions.
- The elements of a Pascal array can be of any type except a file type. In particular, the elements can be arrays or records.
- The values used to index elements of a Pascal array can be of any scalar or subrange type except integer. (They can be a subrange of integer.) This means that the first element of an array is not necessarily element 0, or element 1; it depends on how the array is declared.

An array can be treated as a unit, without indexing, in three ways:

- It can be passed to a procedure or function as an actual parameter, if its type is "congruent" to the type of the formal parameter (this term is explained in Congruent Array Types later in this chapter).
- It can be assigned to another array of congruent type.
- It can be compared to another array of congruent type.

The syntax of an array type is:

array type

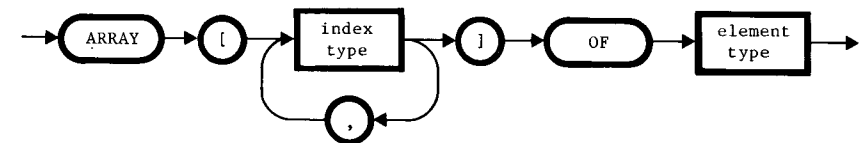

Note that there can be more than one index type: one for each dimension of the array type. First we will consider one-dimensional arrays.

## One-Dimensional Arrays

An array type can be used in a type declaration as follows:

```
TYPE VALS = ARRAY [0..99] OF REAL;
```

or in a variable declaration as follows:

```
VAR VALUES: ARRAY [0..99] OF REAL;
```

The index type is usually a subrange of type integer, but it can also be any scalar or subrange type except the integer type. The element type can be any type except a file type.

The index type determines the number of elements in the array: there is one element for each possible value of the index. For example, consider the following declaration:

```
VAR TENREALS: ARRAY [0..9] OF REAL;
```

The index type is the subrange 0..9, so the array TENREALS will have 10 elements, each one of which is of type real. The first element is TENREALS[0], the next is TENREALS[1], etc.; the last element is TENREALS[9].

The reason that the type integer is not allowed for array indices is simply that the array would have more elements than could be stored in memory.

## Multidimensional Arrays

Since the type of the elements can be anything except a file type, you can declare an array of arrays. For example, here is a declaration of an array whose elements are arrays like the one declared above:

```
VAR SQUARE: ARRAY [0..9] OF ARRAY [0..9] OF REAL;
```

SQUARE has ten elements, each of which is an array of ten real values. The variable SQUARE[3] is an array variable, and you can think of SQUARE as a 10x10 matrix of real values; SQUARE[3] can be thought of as a row, and its real elements can be thought of as the column elements of the row. To select one of the real values from the matrix, you need two indices; for example, SQUARE[6][5] refers to row 6, column 5.

Thinking of the first index as a row index and the second as a column index is a matter of choice; you could just as well think of the first index as a column index and the second as a row index.

Instead of writing SQUARE[6][5], you can write both indices in one pair of brackets, with a comma to separate them: SQUARE[6,5]. The two notations are equivalent and interchangeable. Similarly, you can condense the declaration of SQUARE by writing

```
VAR SQUARE: ARRAY [0..9, 0..9] OF REAL;
```

This declaration means exactly the same thing as the previous one, and has the advantage of being more explicit to the human reader. It obviously declares a two-dimensional array of reals. Here is a declaration of a three-dimensional array:

```
VAR SPACE: ARRAY [0..MAXX, 0..MAXY, 0..MAXZ] OF REAL;
```

where MAXX, MAXY, and MAXZ are previously declared integer constants. A Pascal array can have as many dimensions as desired.

## Other Index Types

So far, all the examples have shown integer subranges as index types, since this is the most common usage. However, remember that an index type can be any scalar type except integer. For example, it can be char, or a subrange of char. The declaration

```
VAR CRYPT: ARRAY [CHAR] OF CHAR;
```

creates an array of characters which is indexed by character values. It has one element for each possible character value, or 256 elements in all. Such an array could be useful for a cryptography routine.

The indices of a multidimensional array can be of different types. For a more complicated cryptographic scheme, you might declare

```
VAR CRYPTARR: ARRAY [CHAR, 1..KEYMAX] OF CHAR;
```



where KEYMAX is a previously declared constant. CRYPTARR contains one element for each possible combination of a character value and an integer value from 1 to KEYMAX.

## Index Values

In a reference to a specific element of an array, each index value is given as an expression. For example, the following is a valid assignment statement:

```
SPACE[X,Y,Z] := SPACE[X-DX, Y-DY, K];
```

The only restriction on an expression used as an index value is that the type of the expression's value must be compatible with the index type in the array declaration; if the index type is a subrange, the index value must be within the subrange.

## Congruent Array Types

In the following sections the term "congruent type" is used. To say that two array types are congruent means that they have elements of the same type, the same dimensionality, and the same number of elements in each dimension. However, the index type in a particular dimension does not have to be identical for the two arrays, as long as the number of elements in the dimension is the same. For example, these three array types are congruent even though they are not identical:

```
TYPE A = ARRAY [0..25, 0..18] OF INTEGER;
      C = ARRAY [10..35, 10..28] OF INTEGER;
      D = ARRAY ['A'..'Z', 0..18] OF INTEGER;
```

Each of these types is a 26-by-19 array of integers, and so they are congruent types even though the index types are different. The two array types

```
TYPE E = ARRAY [1..5, 1..10] OF REAL;
      F = ARRAY [1..50] OF REAL;
```

are not congruent, even though both contain 50 real elements. Type E is a two-dimensional 5-by-10 array and type F is one-dimensional.

## Passing Arrays

A procedure or function parameter (either value or variable) can be declared to be an array; then when the procedure or function is called, an array of congruent type can be passed as the actual parameter.

The following example shows a way to use this technique:

```
PROGRAM X;

CONST MINX = -100; MINY = -32; MINZ = 0;
      MAXX = 100; MAXY = 156; MAXZ = 96;

TYPE XINDEX = MINX..MAXX;
      YINDEX = MINY..MAXY;
      ZINDEX = MINZ..MAXZ;
      THREESPACE = ARRAY [XINDEX, YINDEX, ZINDEX] OF REAL;

VAR MAINSPACE, BUFFERSPACE, SCRATCHSPACE: THREESPACE;
    NOMINAL, STRENGTH: REAL;
    ...

PROCEDURE INITSPACE (VAR S: THREESPACE; VALUE: REAL);
{Set all elements of specified array to specified value.}
VAR X: XINDEX; Y: YINDEX; Z: ZINDEX;
BEGIN
  FOR X := MINX TO MAXX DO
    FOR Y := MINY TO MAXY DO
      FOR Z := MINZ TO MAXZ DO S[X,Y,Z] := VALUE
    END;
  ...
END;

FUNCTION MEAN (A: THREESPACE): REAL;
{Return the mean of all elements in array.}
VAR X: XINDEX; Y: YINDEX; Z: ZINDEX; SUM: REAL;
BEGIN
  SUM := 0.0;
  FOR X := MINX TO MAXX DO
    FOR Y := MINY TO MAXY DO
      FOR Z := MINZ TO MAXZ DO SUM := SUM + A[X,Y,Z];
    MEAN := SUM / ( (MAXX-MINX+1)*(MAXY-MINY+1)*
                  (MAXZ-MINZ+1) )
  END;
```

```

...
BEGIN
  ...
  INITSPACE(MAINSPACE, NOMINAL);
  ...
  STRENGTH := MEAN(MAINSPACE);
  ...
END.

```

The INITSPACE procedure has a variable parameter, S, which is an array of type THREESPACE. In the main program, INITSPACE is called with the array MAINSPACE as actual parameter; this is legal because MAINSPACE is also of type THREESPACE. When INITSPACE assigns the value of NOMINAL to each element of S, the effect is to assign the value of NOMINAL to each element of MAINSPACE.

The MEAN function has a value parameter, A, which is an array of type THREESPACE. It returns the mean of the values of the elements of the array. In the main program, MEAN is called with MAINSPACE as its actual parameter; it therefore returns the mean of all the element values of MAINSPACE.

## Array Assignments

An array can be assigned to another array of congruent type. For example, if we have the declarations

```
VAR AAA, BBB: ARRAY [1..255] OF INTEGER;
```

then we can assign all the values of BBB to the corresponding elements of AAA as follows:

```
AAA := BBB
```

## Array Comparisons

An array can be compared with another array of congruent type. The only comparison operators allowed for arrays are the = and <> operators (except as noted below under "Packed Character Arrays"). For example, if we have the declarations

```
VAR CCC, DDD: ARRAY [0..99] OF REAL;
```

then we can compare CCC to DDD as follows:

```
CCC = DDD
```

The result of this expression is TRUE if every element of CCC has the same value as the corresponding element of DDD. The other possible comparison is

```
CCC <> DDD
```

which is TRUE if any element of CCC has a different value from the corresponding element of DDD.



Two packed arrays can be compared successfully only if all 16 bits in each word of each array have been defined. See the following section.

## Packed Arrays

Any array can be declared as a packed array by inserting the word PACKED in the declaration as shown below.

Ordinarily, every scalar value or variable in Apple III Pascal occupies one 16-bit word (two 8-bit bytes) of memory. This includes scalar types such as boolean values, which can logically be represented by a single bit, or char values which can logically be represented in only eight bits. Obviously the use of a whole word to store such a value is a waste of memory, but not a significant waste in the case of single values.

If you have a large array with elements that can logically be represented in less than one word, the waste of memory becomes more significant. The most obvious example is large arrays of characters, where the waste is 50% if each char value occupies a word. The declaration

```
VAR CHBUF: ARRAY [0..2047] OF CHAR;
```

creates an array that occupies 2048 words of memory, or 4096 bytes. To avoid the waste, you can instead declare

```
VAR CHBUF: PACKED ARRAY [0..2047] OF CHAR;
```

This causes the char elements of the array to be packed, two in each word. The packed array occupies only 1024 words or 2048 bytes.

When the program accesses an element of a packed array, a value must be either unpacked from the array or packed into it. This is done automatically, but requires some extra time for execution. Thus the saving in storage space is a tradeoff against execution speed and extra code space.

As will be seen in the next chapter, record types can also be packed. In fact, you can insert the word PACKED into the definition of any structured type, including sets and files. However it has no effect except with arrays and records.

There is one restriction on the use of packed values: an element of a packed array or record cannot be passed to a procedure or function as an actual variable parameter.

In a packed array (or record), 16-bit words are still the unit of storage; the difference is that one word may contain more than one value. Values are never packed across a word boundary; for example, consider this array:

```
VAR XXX: PACKED ARRAY [1..3] OF 0..127;
```

To store a value in the range 0..127 requires just 7 bits, logically. Thus two such values can be stored in one 16-bit word, with two bits left over. The array XXX occupies two words of memory: one word contains the elements XXX[1] and XXX[2], and the second word contains the element XXX[3].



It is easy to be mistaken about how a particular array will be packed. When in doubt, you can use the built-in procedure SIZEOF to find out the actual number of bytes occupied by any data type as explained in Chapter 13. The following points about packing should be kept in mind if you are trying to solve a critical space problem.

Since the word is the basic unit of storage, the minimum size for any packed array is one word. Consider the array type

```
TYPE EIGHTBITS = PACKED ARRAY [0..7] OF BOOLEAN;
```

Logically, this array type only requires one byte, since each of its 8 elements only requires one bit. However a variable of type EIGHTBITS actually occupies one word or 16 bits, since that is the minimum. Now consider

```
VAR BATS: PACKED ARRAY [0..3] OF EIGHTBITS;
```

or its exact equivalent

```
VAR BATS: PACKED ARRAY [0..3, 0..7] OF BOOLEAN;
```

BATS consists of four packed arrays, each containing eight booleans. You might expect BATS to occupy a total of 32 bits, or two words; but as we have just seen, a packed array of eight booleans takes a whole word. Therefore BATS occupies four words, not two. Furthermore, note that

```
VAR FATS: PACKED ARRAY [0..7, 0..3] OF BOOLEAN;
```

occupies eight words!

In general, elements are packed only if each element can be represented in eight bits or less--in other words, only if two or more elements can be packed into a word. As the previous examples show, if the "elements" under consideration are arrays, they always require one or more words and can never be packed.

This leads to the fact that the word PACKED, in an array declaration, has an effect only when it appears just before the last occurrence of the word ARRAY. In other words, only the last dimension of an array can actually be packed. For example, the following two declarations are not equivalent:

```
VAR E: PACKED ARRAY [0..9] OF ARRAY [0..3] OF CHAR;
VAR F: PACKED ARRAY [0..9, 0..3] OF CHAR;
```

The array E is not packed, because the word PACKED is not just before the last occurrence of the word ARRAY. The array F is packed, however.

## Packed Character Arrays

One-dimensional packed arrays of characters have some special properties that go beyond what is allowed with other array types.

A string constant can be assigned to a one-dimensional packed array of characters, if the number of elements in the array is exactly the same as the number of characters in the string constant. (See next section for details of string constants.)

Two one-dimensional packed arrays of char that have the same number of elements can be compared using the >, <, <=, and >= operators. The comparison is done as if the arrays were being put in "alphabetical order" according to the ordering of the ASCII character set. For example, if arrays A and B are declared as follows:

```
VAR A, B: PACKED ARRAY [1..3] OF CHAR;
```

and during program execution the following assignments are made:

```
A := 'cat';
B := 'dog'
```

Then A contains the characters "cat" and B contains the characters "dog". A is "less than" B, and the following expressions are valid:

```
A = B {result is FALSE}
A <> B {result is TRUE}
A > B {result is FALSE}
A < B {result is TRUE}
A >= B {result is FALSE}
A <= B {result is TRUE}
```

The same comparisons can be made between a one-dimensional packed array of characters and a string constant, if the number of elements in the array is the same as the number of characters in the string constant. The comparisons above could be written as

```
A = 'dog' {result is FALSE}
A <> 'dog' {result is TRUE}
A > 'dog' {result is FALSE}
A < 'dog' {result is TRUE}
A >= 'dog' {result is FALSE}
A <= 'dog' {result is TRUE}
```

One-dimensional packed arrays of characters are also handled in a special way by the built-in procedures WRITE and WRITELN as explained in Chapter 11.

## Sets

In Pascal, a set is a collection of distinct values, all of the same scalar type. The values are called members of the set; the type of the members is called the base type of the set. The syntax of a set type is

set type

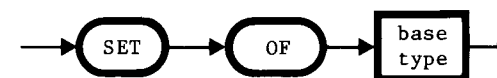

Here are some examples of set variable declarations:

```
VAR LETTERS, SPECIALCHARS, PRINTINGCHARS: SET OF CHAR;
    DIGITS: SET OF '0'..'9';
    COLORS: SET OF (VIOLET, BLUE, GREEN, YELLOW,
                   ORANGE, RED);
```

A set type specifies all the possible members of a set of that type. For example, a SET OF CHAR can contain any collection of distinct char values. The term "distinct" here means that a particular char value can only appear once in the set; for example, the set DIGITS, declared above, either contains the character '5' or it doesn't.

When the type given after the words SET OF is a subrange, the base type of the set is the base type of the subrange. Thus in the second example above (SET OF '0'..'9'), the base type of the set DIGITS is the char type; the set can contain only the characters '0' through '9'.

## Set Values

To understand set values, it may be helpful to know that a set value is represented internally as a bit pattern, with a bit for each possible member of the set. Each of these bits indicates whether that possible member is actually a member. The point of

this is that although a set is a collection of members, a set value is a single value.

To write a set value explicitly, you specify its members between square brackets. For example, suppose that the variable SPECIALCHARS has been declared as a SET OF CHAR (as shown above). Now consider the assignment statement

```
SPECIALCHARS := ['.', ',', ';', ':', '(', ')']
```

After this assignment, SPECIALCHARS is the set containing the period, comma, semicolon, colon, and left and right parentheses. Internally, this value is represented by a bit pattern containing 256 bits, one for each possible char value. In this pattern, the particular bits corresponding to the characters that are members of the set are "on" and the other bits are "off."

When the members form a subrange, you can use the subrange notation, as in

```
DIGITS := ['0'..'9']
```

This makes DIGITS the set of all characters from '0' through '9'. Alternatively, if you wanted DIGITS to contain only octal digits, you could write

```
DIGITS := ['0'..'7']
```

This makes DIGITS the set of all characters from '0' through '7'. You can also use more than one subrange and mix subranges and individual members as in the following:

```
LETTERS := ['A'..'Z', 'a'..'z']
COLORS := [VIOLET..GREEN, ORANGE];
```

After these two assignments, LETTERS is the set of all capital letters and all lower-case letters, and COLORS is the set containing VIOLET, BLUE, GREEN, and ORANGE.

A set value written with square brackets in this manner is called a set constructor. The syntax for a set constructor is

#### set constructor

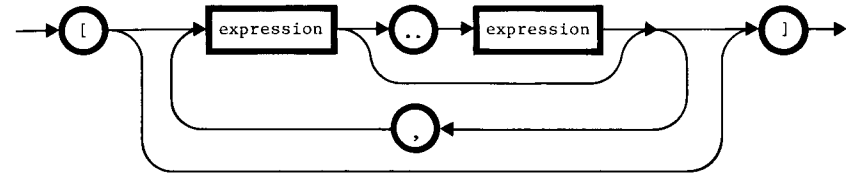

The set constructor [] denotes the empty set.

### Restrictions on Sets

The base type of a set cannot have more than 512 values. A set cannot contain any value whose ordinality is less than 0 or greater than 511. In particular, it cannot contain any integer less than 0 or greater than 511. An attempt to assign more than 512 members to a set, or to assign an integer member outside the range 0..511, results in a run-time error which halts the program.

The formula for the number of words of storage, given the number of members in a set, is

$$((n-1) \text{ DIV } 16) + 1$$

where n is the number of possible values in the base type.

A set of 512 members occupies 32 words of storage.

### The IN Operator

The IN operator is used to test whether a particular scalar value is a member of a particular set. The IN operator is a relational operator and has a boolean result. It has the same precedence as the other relational operators.

The IN operator must have a scalar value on the left and a set on the right. The type of the scalar value must be the same as the base type of the set. Suppose that we have the following declarations and assignments:

```

TYPE COLOR = (MAGENTA, CYAN, YELLOW);

VAR LETTERS: SET OF CHAR;
    COLORS: SET OF COLOR;
    INCHAR, TSTCH: CHAR;
    INDEX: INTEGER;
    TINT: COLOR;

BEGIN
  LETTERS := ['A'..'Z', 'a'..'z'];
  COLORS := [MAGENTA, CYAN];
  ...

```

Then the following expressions are valid uses of IN:

```

INCHAR IN LETTERS {TRUE if value of INCHAR is a letter}
TSTCH IN ['a'..'z'] {TRUE if value of TSTCH is a lower-
                    case letter}
SUCC(TINT) IN COLORS {TRUE if successor of value of TINT
                    is CYAN}
(INDEX + 5) IN [0..255] {TRUE if value of (INDEX + 5) is
                    in the range 0..255}

```

All of these expressions could be replaced with constructs that do not use sets; for example, INCHAR IN LETTERS could be replaced with

```

(INCHAR >= 'A') AND (INCHAR <= 'Z')
OR (INCHAR >= 'a') AND (INCHAR <= 'z')

```

However, the expression INCHAR IN LETTERS is not only more straightforward, it executes faster. Set operations in general are quite fast.

## Combining Sets

So far, we have only seen two ways to represent set values: set variables, and set constructors. Such set values can also be combined to form expressions with set results. The operators are +, -, and \*. These symbols are also used with numeric operands to perform arithmetic. They have different meanings when the operands are set values, but they have the same precedence whether they function as set operators or arithmetic operators.

The + operator forms a set union. If A and B are set values with members of the same type then the value of A + B (or B + A) is

the set that contains all members of A and all members of B.

For examples of the use of set unions, suppose that we have the declarations:

```

VAR CAPS, LOWERS, LETTERS, DIGITS, ALPHANUMERICS:
    SET OF CHAR;

```

and the assignments

```

CAPS := ['A'..'Z'];
LOWERS := ['a'..'z'];
DIGITS := ['0'..'9'];

```

Then we can conveniently make the following assignments for LETTERS and ALPHANUMERICS:

```

LETTERS := CAPS + LOWERS;
ALPHANUMERICS := LETTERS + DIGITS;

```

A common use of the union operator is to add a single new member to a set. Suppose that we wish to add the character '\$' to the set ALPHANUMERICS:

```

ALPHANUMERICS := ALPHANUMERICS + ['$']

```

The - operator forms a set difference. If A and B are set values with members of the same type then the value of A - B is the set that contains all members of A that are not members of B. For example, the value of the expression

```

[CHR(0)..CHR(255)] - LETTERS

```

is the set of all character values that are not letters. You can also use the difference operator to remove a single value from a set. For example, the value of the expression

```

LETTERS - ['A']

```

is the set of all letters except the letter 'A'.

The \* operator forms a set intersection. If A and B are set values with members of the same type then the value of A \* B (or B \* A) is the set that contains all members of A that are also members of B. For example, suppose that we have the declarations

---

```
VAR COMMANDS, OPTIONS: SET OF CHAR;
```

and the assignments

```
COMMANDS := ['A', 'S', 'M', 'D', 'E', 'O'];
OPTIONS := ['B', 'O', 'D', 'H']
```

then the value of the expression

```
COMMANDS * OPTIONS
```

is the set containing the characters 'O' and 'D'.

## Comparing Sets

Two sets that have the same base type can be compared using the = and <> operators, to see if they are equal or unequal. They can also be compared using the <= and >= operators, to see if one set contains the other. These operators produce boolean results.

The same symbols are used for arithmetic comparison; they have different meanings when the operands are set values, but they have the same precedence whether they function as set comparisons or arithmetic comparisons. Note that the comparisons > and < cannot be used with sets.

With set operands, the = operator denotes set equality and the <> operator denotes set inequality. Two sets are said to be equal if they contain exactly the same elements, and unequal otherwise.

With set operands, the >= operator means "includes." Set A includes set B if every member of B is also a member of A. Note that A may contain other members which are not in B. Similarly, the <= operator means "is included in."

## Strings

A string value is a sequence of up to 255 characters. Strings are supported by a set of built-in procedures and functions, described further on in this chapter.

---

## String Constants

A string constant consists of the string itself between apostrophes (with a special way of including apostrophes in the string as explained below). The syntax is

string constant

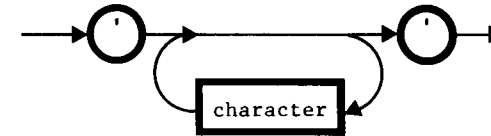

To write a string constant that contains an apostrophe, write two apostrophes as in the following examples:

```
'Can't find the specified file.'
'The challenger's score is: '
'Type either 'yes' or 'no''
```

A string constant can also be declared with an identifier, as in the following:

```
CONST ERRMSG = 'Can't find the specified file';
```

Note that a string constant must be on a single line in the program; it cannot contain a line-break.

## String Variables

A string variable is a variable whose value at any point during program execution is a string. String variables are usually treated as single units, but it is possible to pick out a single character value from a string variable by indexing it in the same way that an array element is selected by indexing.

A string variable is created by declaring it with a string type. The syntax of a string type is

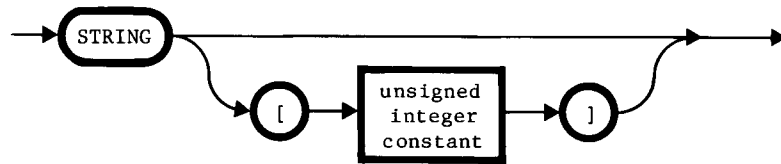
string type

Here are some examples of string variable declarations:

```
VAR MSGBUFFER: STRING[255];
    INPUTNAME, OUTPUTNAME: STRING;
```

The number in brackets, if used, specifies the maximum length of the string. The number can be any integer from 1 through 255. If no number is specified, the maximum length is 80. Since the string variable's value can change during execution, the system keeps track of the length of the string value; if this length exceeds the maximum, a run-time error occurs.

The value of a string variable can be altered by using an assignment statement with a string constant or another string variable:

```
TITLE := ' This is a title
```

or

```
NAME := TITLE
```

or by means of the READLN procedure as described in Chapter 11:

```
READLN(TITLE)
```

or by means of the string built-ins, described further on in this chapter.

A string value can be compared to any other string value, regardless of length. Also, as previously mentioned, a string value can be compared to a one-dimensional packed array of characters if the length of the string is the same as the number of elements in the array.

The relational operators =, <>, <, >, <=, and >= are used. One string is "less than" another if it would come first in an "alphabetic" list of strings based on the ordering of the ASCII character set.

*Elements of a String*

The individual characters within a string are indexed from 1 (not 0!) to the length of the string. For example, if TITLE is the name of a string and we have the assignment

```
TITLE := 'A Quick Brown Fox'
```

then TITLE[1] is a reference to the first character of TITLE, namely the character 'A', and TITLE[17] is a reference to the last character, namely 'x'. The index must not be less than 1 or greater than the length of the string. For example, TITLE[18] would lead to a run-time error.

There is a case where you must assign a character to a string element. It may be necessary to convert the value of a char variable to a one-character string value; for example you may want to add it to a string with the CONCAT procedure (see next section), which requires a string value rather than a char value.

Note that while a one-character string constant is the same thing as a character constant, a string variable whose value is a single character is not the same thing as a character variable and you cannot assign one to the other.

The way to deal with this is shown in the example below, which assumes that the value of the char variable CHVAL is to be concatenated to the value of the string variable LINE. To make this possible we use a string variable named ONECH. First we initialize it with a one-character string constant, so it will have the right length, and then we assign the char value to its element, ONECH[1].

```
ONECH := 'X';
ONECH[1] := CHVAL;
LINE := CONCAT(LINE, ONECH)
```



Beware of zero-length strings: they cannot be indexed at all without causing a run-time error. If a program



indexes a string that might have zero length, it should first use the LENGTH function (see next section) to see if the length is zero. If the length is zero, the program should not execute statements that index the string.

You cannot define a function of type string. However, there are built-in functions of type string as described in the next section.

## String Built-Ins

In the following descriptions, a "string value" means a string variable, a string constant, or any function or expression whose value is a string. Unless otherwise stated all parameters are value parameters.

### The LENGTH Function

The LENGTH function returns the length of a string. LENGTH takes one parameter:

```
LENGTH (STRG)
```

where STRG is a string value parameter. For example, if we have the assignment

```
S := 'abcdefg';
```

then the value of LENGTH(S) is 7 and the value of S[LENGTH(S)] is 'g'.

### The POS Function

The POS function returns an integer value. POS takes two parameters:

```
POS (SUBSTRG, STRG)
```

where both SUBSTRG and STRG are string value parameters. The POS function scans STRG to find the first occurrence of SUBSTRG within STRG. POS returns the index within STRG of the first character in the matched pattern. If the pattern is not found, POS returns zero.

For example, suppose that a string variable named FNAME contains a filename that has been typed on the keyboard. Then the value of POS('.', FNAME) will be 0 if the filename contains no period, 1 if the first character is a period, etc.

### The CONCAT Function

The CONCAT function returns a string value. CONCAT can take any practical number of actual parameters each of which is a string value; the parameters are separated by commas. The syntax of the call is

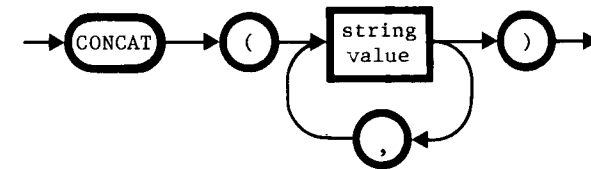

CONCAT returns a string which is the concatenation of all the strings passed to it. For example, if FNAME is a string variable containing a file name from the keyboard, then the statement

```
FNAME := CONCAT(FNAME, '.TEXT')
```

has the effect of appending the suffix .TEXT to the name. Another example: if we have the assignments

```
FIRSTNAME := 'George';
LASTNAME := 'Washington'
...
BOTHNAMES := CONCAT(LASTNAME, ', ', FIRSTNAME)
```

then the statement

```
WRITELN(BOTHNAMES)
```

will print

```
Washington, George
```

## The COPY Function

The COPY function returns a string value. COPY takes three parameters:

```
COPY (STRG, INDEX, COUNT)
```

where STRG is a string value parameter and both INDEX and COUNT are integer value parameters. COPY returns a string containing COUNT characters copied from STRG starting at the INDEXth position in STRG. Example:

```
TL := 'KEEP SOMETHING HERE';
KEPT := COPY(TL, POS('S', TL), 9);
WRITELN(KEPT)
```

This will print:

```
SOMETHING
```

## The DELETE Procedure

The DELETE procedure modifies the value of a string variable. DELETE takes three parameters:

```
DELETE (STRG, INDEX, COUNT)
```

where STRG is a string variable parameter and both INDEX and COUNT are integer value parameters. DELETE removes COUNT characters from STRG starting at the INDEX specified. Example:

```
LATIN := 'Cartago delenda est.';
DELETE(LATIN, POS('delenda', LATIN), LENGTH('delenda '));
WRITELN(LATIN)
```

This will print:

```
Cartago est.
```

## The INSERT Procedure

The INSERT procedure modifies the value of a string variable. INSERT takes three parameters:

```
INSERT (SUBSTRG, STRG, INDEX)
```

where SUBSTRG is a string value parameter, STRG is a string variable parameter, and INDEX is an integer value parameter. INSERT inserts SUBSTRG into STRG at the INDEXth position in STRG. Example:

```
ID := 'INSERTIONS';
MORE := ' DEMONSTRATE';
DELETE(MORE, LENGTH(MORE), 1);
INSERT(MORE, ID, POS('IO', ID));
WRITELN(ID)
```

This will print:

```
INSERT DEMONSTRATIONS
```

You can insert a substring at the end of a string by using INDEX value LENGTH(string)+1. For example

```
S := 'ABC'
T := 'DE'
INSERT(T,S,LENGTH(S)+1);
```

will produce a string of length 5 containing

```
'ABCDE'.
```

## The STR Procedure

The STR procedure modifies the value of a string variable. STR takes two parameters:

```
STR ( N , STRG )
```

where N is an integer value parameter, and STRG is a string variable parameter. N may be a long integer.

STR converts the value of N into a string. The resulting string is placed in STRG. Example:

```
INTLONG := 102039503;  
STR(INTLONG, INTSTRING);  
INSERT('.', INTSTRING, LENGTH(INTSTRING)-1);  
WRITELN('$', INTSTRING)
```

This will print:

\$1020395.03

The use of STR requires availability of the long integer procedure, LONGINTIO, which is found in the standard system library file.

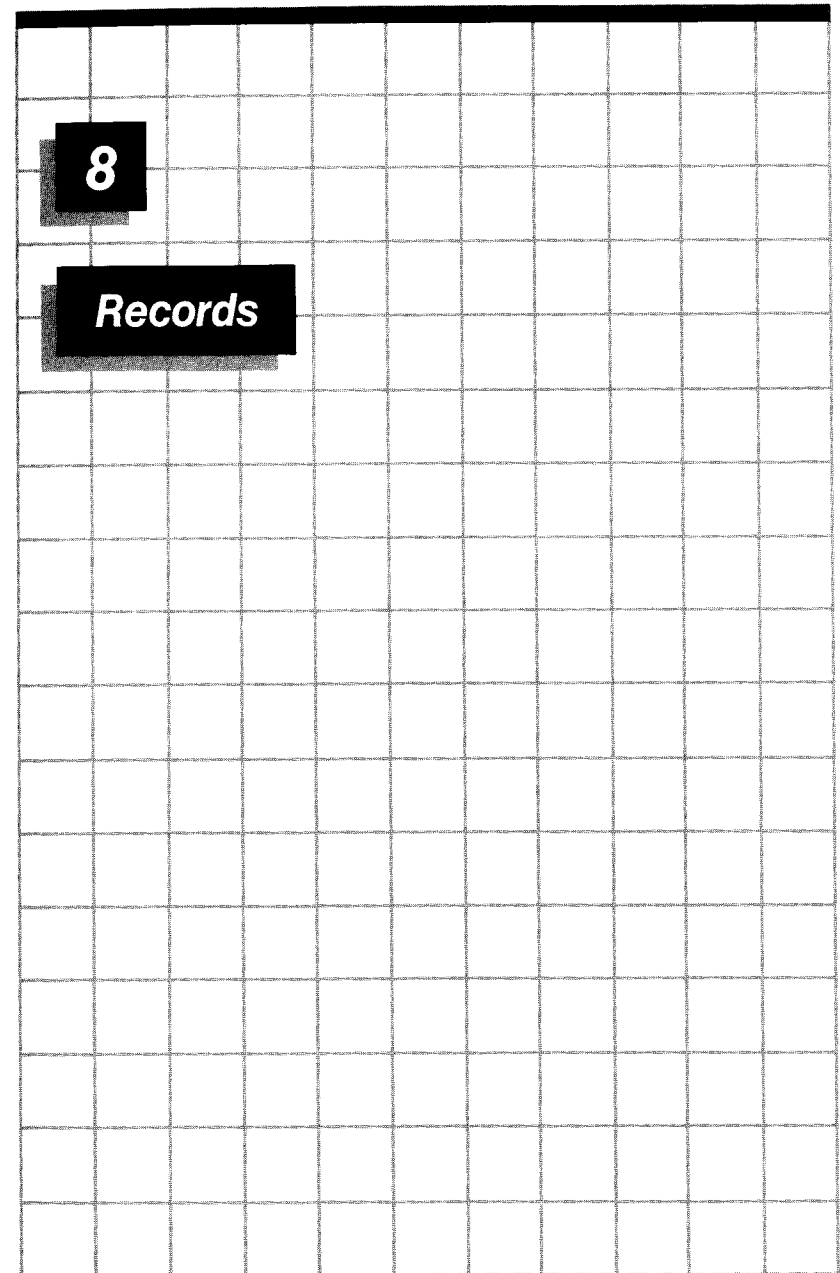

## Record Variables

A record variable is a collection of elements called fields which may be of different types. Each field has its own identifier within the record, and can be individually referenced; or the record can be referenced as a whole.

As will be seen in later chapters, record types are extremely useful in conjunction with dynamic variable allocation and files; in this chapter, the discussion is restricted to ordinary record variables (which are neither dynamic variables nor components of files).

The syntax for a record type is

record type



The syntax for a field list is

field list

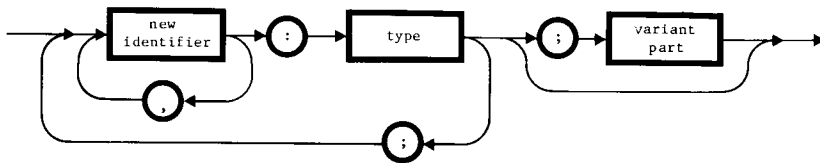

Each field identifier is the name of a distinct variable, or field, within that record type. The type of a field may be anything except a file type. The syntax for the variant part is given in the next section; in this section, we assume that there is no variant part.

The following record type can be used to represent a date:

```

DATE = RECORD
    DAY, YEAR: INTEGER;
    MONTH: STRING
END;
  
```

If you declare a variable named TODAY, of type DATE, then the fields of this variable can be referenced as TODAY.DAY (an integer variable), TODAY.YEAR (another integer variable), and TODAY.MONTH (a string variable).

The record type below uses the type DATE for two of its fields. It could be used in a checking-account program.

```

TYPE CHECK = RECORD
    CHECKNUMBER: INTEGER;
    DATEWRITTEN, DATEPAID: DATE;
    AMOUNT: REAL;
    RECIPIENT: STRING;
    BOUNCED: BOOLEAN
END;
  
```

Type CHECK contains six fields. A checkbook might be represented as an array of records of type CHECK:

```

VAR CHECKBOOK: ARRAY[1..100] OF CHECK;
  
```

To reference a field in a record, merely write a reference to the record, then a period, then the field identifier. For example, with the declarations above,

- CHECKBOOK[3] refers to a particular check (a variable of type CHECK).
- CHECKBOOK[3].CHECKNUMBER refers to the number of that check (an integer variable).
- CHECKBOOK[3].DATEWRITTEN refers to the date on which that check was written (a variable of type DATE).
- CHECKBOOK[3].DATEWRITTEN.MONTH refers to the month within the date (a string variable).

To assign numbers to the checks in the array you could use the statement:

```
FOR I := 1 TO 100 DO CHECKBOOK[I].CHECKNUMBER := I;
```

### Variant Records

The optional variant part of a record type contains two or more alternate field lists. For example, a variant part of a record could be declared to contain either a string or two reals, an integer, and a string.

To understand what this means, recall that a Pascal variable consists of two things:

- Allocated memory space to hold the value of the variable in binary form
- Type information which tells the system how to interpret the binary information.

When a variant part is declared, the Compiler allocates enough space for the largest of the alternate field lists in the variant part. All of the alternate field lists then use the same allocated space.

The syntax for a variant part is

### variant part

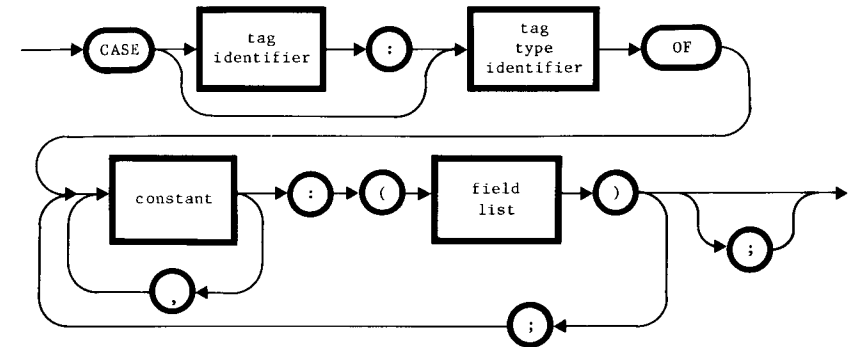

The variant part resembles a CASE statement, and its meaning is closely related. The tag identifier and tag type serve to declare a tag field, which can be of any scalar type. The tag field is an ordinary field of the record (just as if it were declared before the variant part).



Note that the tag identifier is optional; if it is omitted, then there is no tag field. In the rest of this chapter, we assume that the tag field is present; for information on the use of variants without tag fields, see Appendix G.

The tag type cannot be omitted, because it also relates to the constants within the variant part: each constant in the variant part must be one of the possible values of the tag identifier. Each of these constants is a "label" for a field list, enclosed in parentheses.

The variant part syntax allows you to declare records of a single type which can have more than one configuration -- each of the field lists in the variant part represents a specific, distinct configuration.

At run time, the program can refer to any of the fields in the variant part. All of the "cases" or field lists of a variant

part occupy the same space in memory, on the assumption that at any point in the program, the data in that space is to be interpreted according to just one field list.

The following example shows a record that has a variant part.

```
TYPE YESNO = (YES, NO);
   IDENT = RECORD
       LASTNAME, FIRSTNAME: STRING[10];
       CASE HASLIC: YESNO OF
           YES: (LICNO: INTEGER[10]);
           NO: (SOCSEC: STRING[10])
       END;
```

A record of type IDENT contains four fields: LASTNAME, FIRSTNAME, HASLIC and either LICNO or SOCSEC. The program can use the tag field HASLIC to determine which variant field, LICNO or SOCSEC, should be used.

Fields in the variant part of a record are referenced exactly as normal fields are. At any point in the program, you can refer to either IDENT.LICNO or IDENT.SOCSEC. The two references refer to the same physical data; the difference is that a reference to IDENT.LICNO interprets the data as a ten-digit long integer, while a reference to IDENT.SOCSEC interprets the same data as a string of up to ten characters.

Now suppose we have an array of records of type IDENT, and some other variables to contain information input by the user:

```
VAR IDCARD: ARRAY [1..1000] OF IDENT;
    LASTNAMEIN, FIRSTNAMEIN, SSNUMIN: STRING[10];
    HASLICIN: YESNO;
    LICNUMIN: INTEGER[10];
```

The following assignments can be made to a particular record, IDCARD[N]:

```
IDCARD[N].LASTNAME := LASTNAMEIN;
IDCARD[N].FIRSTNAME := FIRSTNAMEIN;
IDCARD[N].HASLIC := HASLICIN;
CASE IDCARD[N].HASLIC OF
    YES: IDCARD[N].LICNO := LICNUMIN;
    NO:  IDCARD[N].SOCSEC := SSNUMIN
END
```

Notice that the tag field is used to select the proper variant field.



The tag field does not have to be declared after the word CASE; as mentioned before, it is really just another field of the record. In fact, the type IDENT declared above can be thought of as an abbreviation for the declaration

```
TYPE IDT00 = RECORD
    LASTNAME, FIRSTNAME: STRING[10];
    HASLIC: YESNO;
    CASE YESNO OF
        YES: (LICNO: INTEGER[10]);
        NO: (SOCSEC: STRING[10])
    END;
```

where the tag field is declared before the variant part. However, note that the tag type must appear after the word CASE, since it determines the possible values for the constants in the variant part.



The tag field does not automatically control which fields can be referenced in the variant part of the record. It is up to the program to use the tag field as a control, as shown in the example above.

## The WITH Statement

The WITH statement is a shorthand method for referencing elements of a record. It provides a means by which the fields of specified records can be referenced using only their field identifiers. The syntax of a WITH statement is

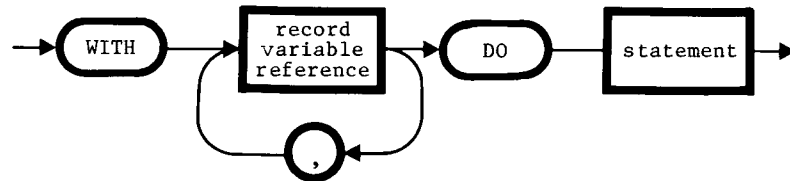
with statement

The meaning of the record variable reference is determined once, before the statement following DO is executed.

Earlier, we showed the following assignments to the record IDCARD[N]:

```
IDCARD[N].LASTNAME := LASTNAMEIN;
IDCARD[N].FIRSTNAME := FIRSTNAMEIN;
IDCARD[N].HASLIC := HASLICIN;
CASE IDCARD[N].HASLIC OF
  YES: IDCARD[N].LICNO := LICNUMIN;
  NO:  IDCARD[N].SOCSEC := SSNUMIN
END
```

These statements can be abbreviated by using a WITH statement:

```
WITH IDCARD[N] DO BEGIN
  LASTNAME := LASTNAMEIN;
  FIRSTNAME := FIRSTNAMEIN;
  HASLIC := HASLICIN;
  CASE HASLIC OF
    YES: LICNO := LICNUMIN;
    NO:  SOCSEC := SSNUMIN
  END
END
```

Variables that are not fields of records may be referenced as usual within the WITH statement. For example, if COUNTER is declared as a variable of type integer, then you can write

```
WITH CHECKBOOK[I] DO BEGIN
  COUNTER := COUNTER+1;
  ...
  CHECKNUMBER := COUNTER MOD 1000
END
```

The identifier COUNTER references the integer variable COUNTER (rather than a record field named COUNTER) because the records listed do not have a field named COUNTER.

If one of the fields of a record is itself a record, then nested WITH statements can be used:

```
WITH CHECKBOOK[I] DO WITH DATEWRITTEN DO BEGIN
  CHECKNUMBER := I;
  DAY := 5;    {references CHECKBOOK[I].DATEWRITTEN.DAY}
  MONTH := 'JULY'
END
```

For convenience, these nested WITH statements can be combined into a single WITH statement:

```
WITH CHECKBOOK[I], DATEWRITTEN DO BEGIN
  CHECKNUMBER := I;
  DAY := 5;    {references CHECKBOOK[I].DATEWRITTEN.DAY}
  MONTH := 'JULY'
END
```

When the same field name occurs in more than one record, and both records are "abbreviated" via the WITH statement, a potential ambiguity arises. Consider the following:

```
WITH CHECKBOOK[I], DATEWRITTEN, DATEPAID DO BEGIN
  ...
  DAY := 5;
  ...
END
```

The field DAY occurs both in CHECKBOOK[I].DATEPAID.DAY and in CHECKBOOK[I].DATEWRITTEN.DAY; which one is referenced in the assignment statement? The answer is that CHECKBOOK[I].DATEPAID.DAY is referenced, because DATEPAID is the last record listed in the WITH statement.

The confusion arises because DATEWRITTEN and DATEPAID are "parallel;" that is, one is not a field of the other. WITH statements that allow this kind of confusion should be avoided. For example, the following WITH construction can be used to reference fields of the same name in both DATEWRITTEN and DATEPAID:

```

WITH CHECKBOOK[I] DO BEGIN
  WITH DATEWRITTEN DO BEGIN
    ...
    DAY := 5;
    ...
  END;
  WITH DATEPAID DO BEGIN
    ...
    DAY := 6;
    ...
  END;
END;
END

```

## Comparisons and Assignments

Although most assignments to records are done on a field by field basis, it is also possible to make assignments between entire records of the same type. For example, the result of the assignment

```
CHECKBOOK[I] := CHECKBOOK[I + 1]
```

is to assign to every field in CHECKBOOK[I] the value of its corresponding field in CHECKBOOK[I + 1].



Actually, assignments between records of different types are allowed if the types are "congruent" -- that is, if every field in one record has a corresponding field, of the same type but not necessarily of the same name, in the other record.

The only operations that can be performed on records are comparisons, giving boolean results. Of the relational operators, only

```

=      equal to
<>    not equal to

```

can be used with records. The rules for comparing two records are the same as the rules for assignment to records: the two records being compared must have corresponding fields of identical types.



Two packed records can be compared successfully only if all 16 bits in each word of each record have been defined. See the following section.

## Packed Records

The following record declaration declares a record with four fields. The entire record occupies one 16-bit word as a result of declaring it to be packed.

```

VAR R: PACKED RECORD
  I,J,K: 0..31;
  B: BOOLEAN
END;

```

The fields I, J, K each take up five bits in the word. The boolean field B occupies the 16th bit of the same word.

In much the same manner that multidimensional arrays can be packed, packed records may contain fields which themselves are packed records or packed arrays. Slight differences in the way in which declarations are made will affect the degree of packing achieved. For example, note that the following two declarations are not equivalent:

```

VAR A: PACKED RECORD
  C: INTEGER;
  F: PACKED RECORD
    R: CHAR;
    K: BOOLEAN
  END;
  H: PACKED ARRAY[0..3]
    OF CHAR
END;

VAR B: PACKED RECORD
  C: INTEGER;
  F: RECORD
    R: CHAR;
    K: BOOLEAN
  END;
  H: PACKED ARRAY[0..3]
    OF CHAR
END;

```

As with packed arrays, the word PACKED should appear with every occurrence of the word RECORD or ARRAY to ensure that all fields of the record are actually packed. In the above example, only record A has the F field packed into one word. In B, the F field is not packed and therefore occupies two 16-bit words. It is important to note that a packed or unpacked array or record which is a field of a packed record will always start at the beginning



of the next word boundary. This means that in the case of A, even though the F field does not completely fill one word, the H field starts at the beginning of the next word boundary.

A variant part may be used in a packed record, and the amount of space allocated to it will be the size of the largest variant among the various cases. The details of the packing methods are beyond the scope of this document.

```
VAR K: PACKED RECORD
    B: BOOLEAN;
    CASE F: BOOLEAN OF
        TRUE: (Z: INTEGER);
        FALSE: (M: PACKED ARRAY[0..3] OF CHAR)
    END;
```

In the above example the B and F fields are stored in two bits of the first 16-bit word of the record. The remaining fourteen bits are not used. The size of the variant part is always the size of the largest variant, so in the above example the variant part will occupy two words, one byte for each of four characters. Thus the entire packed record will occupy three words.

9

## Pointers and Dynamic Variables

## Concepts

Up to this point we have dealt only with static variables: these are declared in the program and the Compiler responds to the declaration by

- allocating memory space to hold the value of the declared variable at run time;
- associating the declared identifier with that memory space, and with the type information in the declaration.

In other words, everything about a static variable except its actual value is determined when the program is compiled. Only the value is determined at run time. Variant records may appear to be an exception to this statement, but really they are just a slightly more complicated case; the Compiler allocates enough space for the largest variant of a record variable, and at run time the field identifier determines how this space is used. Again, all information about the variable is determined at compile time, except for the actual value(s).

Some programs need a more flexible kind of variable. For example, imagine a program that will read a sequence of records from a file or from the terminal; suppose that the records are of type

```
TYPE RTYPE = RECORD
    INTVALS: INTEGER;
    RVAL: REAL;
END;
```

At the time when the program is written, the difficulty is that we don't know how many records will be read. How can we create variables to hold the records? One way is to make a generous guess and declare an array. For example if we think the number of records will not exceed 100, we could declare

```
VAR REC: ARRAY [1..100] OF RTYPE;
```

This is not very satisfactory; if the number does exceed 100 the program will be unable to cope, and if the number is less than

100 we will have wasted space. The situation calls for the use of dynamic variables.

A dynamic variable is not declared, has no identifier, and is created at run time. Since it has no identifier, it can only be referenced indirectly, by means of a pointer. In Pascal, pointers and dynamic variables are two parts of a single mechanism. Note that this is the only Pascal mechanism for accessing the unallocated memory space that is available at run time.

Instead of declaring the REC array as shown above, we declare

```
VAR PTR: ^RTYPE;
```

This creates a static variable called PTR which is a pointer to a dynamic variable of type RTYPE. At compilation time there is no such variable, but in the program we can write

```
NEW(PTR)
```

NEW is a built-in Pascal procedure. The call shown does two things at run time:

- It creates a new variable of type RTYPE, somewhere in unused memory space.
- It sets the value of PTR so that it points to this new variable.

Now we can refer to the new dynamic variable by writing

```
PTR^
```

which means "the thing pointed to by PTR." We can refer to the fields within the variable by writing PTR^.INTVALS or PTR^.RVAL, just as if "PTR" were the identifier of the variable. However, another NEW(PTR) call will create a second variable of type RTYPE, and then PTR will point to this second variable. At this point you may be wondering how to refer to the first dynamic variable after the second is created, and this point will be dealt with at length further on.

## Pointer Values

Pointer values are generated by NEW and there is no way to write a pointer value explicitly. Therefore you cannot declare a pointer constant; however, there is a built-in pointer constant named NIL, which can be a value of any pointer variable and which points to nothing.

The value of a pointer variable can be changed in only two ways: by giving the pointer variable as a parameter to NEW and by assigning it the value of another pointer variable or NIL.

The only other operation allowed with pointers is comparison using the = and <> operators, yielding a boolean result. Pointers cannot be compared using the <, <=, >, and >= operators, and they cannot be combined using any of the arithmetic operators. Pointers are not a scalar type, and thus do not have successors or predecessors. However, you can use the ORD function with a pointer; the result is an integer which represents a physical address.

For readers who are familiar with pointers in some other language, it must be emphasized that in Pascal you cannot set a pointer to a static variable; pointers can point only to dynamic variables created by NEW.

## Declaring Pointer Variables

A pointer variable is declared by using a pointer type. The syntax for a pointer type is

pointer type

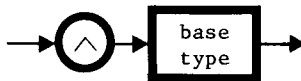

In other words, a pointer type is a base type prefixed with the symbol. The base type specifies the type of variable that a pointer of this type can point to. The base type can be any type except a file type, and there is a special provision: the base type can be an identifier for a variable type that has not yet been declared. This is the only time in Pascal where you can use an identifier that has not yet been declared. Examples:

```
TYPE DATASET = ARRAY [0..25] OF REAL;
     RPTR = ^RTYPE;
     RTYPE = RECORD
         LINK: RPTR;
         DATA: DATASET;
     END;

VAR INDATA: DATASET;
    FIRST, LAST, CURRENT: RPTR;
...

```

The pointer type RPTR is declared using RTYPE as its base type, even though RTYPE is still undefined. Then RTYPE is declared, and it makes use of the RPTR type in its own declaration, for reasons that will be explained below. The RPTR type is used again in a static variable declaration; FIRST and CURRENT are pointers to point to dynamic variables of type RTYPE.

## Using Pointers

The dynamic variable currently pointed to by a pointer is called the object of the pointer. To refer to the object of a pointer, merely refer to the pointer and append the ^ symbol.

For example, suppose that we have the declarations shown above, and the program sets up some values in the array INDATA (perhaps by reading from a file). Now we write

```
NEW(FIRST);
```

which creates a dynamic variable of type RTYPE and sets the pointer FIRST to point to it. The data from the INDATA array can be transferred into the new dynamic variable by writing

```
FIRST^.DATA := INDATA
FIRST^.LINK := NIL
```

Next suppose that the program puts another set of values into INDATA, and we want to transfer these into a second dynamic record. If we again use NEW(FIRST), we will lose the pointer to the first dynamic record; so instead we write

```
LAST := FIRST; {The first record is also the last record}
```

We will leave the value of FIRST unchanged for the rest of the program; it will always point to the first dynamic record. Now, for each new dynamic record required by the program, we use the following:

```
{Create new dynamic record, pointed to by last record's
LINK field;}
NEW(LAST^.LINK);
{Make the new record the last record}
LAST := LAST^.LINK;
{Transfer data into last record}
LAST^.DATA := INDATA;
{Set last record's LINK field to NIL}
LAST^.LINK := NIL
```

The first statement creates a new dynamic record and sets the LINK field of the last record to point to the new record. The second statement sets the LAST pointer to point to the new record, and the third transfers the new data into the new record. The last statement sets the LINK field of the last record to NIL, so that the program can always tell which dynamic record is the last in the list.

When all the data has been stored in dynamic records, the result is a linked list of data arrays, structured as follows:

- The pointer FIRST points to the first record.
- The LINK field of each record except the last points to the next record in the list.
- The last record can be identified by the fact that its LINK field is NIL.

Suppose that PROCESS is a procedure that takes an ARRAY [0..25] OF REAL as its parameter, and we want to use PROCESS on each of the data arrays in the dynamic records. We write

```
{Set current pointer to first record;}
CURRENT := FIRST;
{Repeat as long as CURRENT points to something;}
REPEAT
  {Process data of current record;}
  PROCESS(CURRENT^.DATA);
  {Advance to next record;}
  CURRENT := CURRENT^.LINK
UNTIL CURRENT = NIL
```

A general discussion of linked data structures is beyond the scope of this manual, but the above example shows the essential idea: each record in a linked data structure contains at least one pointer, which can point to another record in the structure. At least one static pointer variable (FIRST in the example) provides an entry into the structure; after using this pointer to begin with, other records are accessed by using the pointers contained in the records.



When a program starts running, pointer variables are not initialized; they have unknown values until they are set by NEW or by assignment. A variable reference using a pointer that has not been set is a reference to some unknown memory location and can have disastrous results.

## The NEW Procedure

As we have already seen, NEW is a built-in procedure that takes a pointer variable as a parameter. NEW creates a dynamic variable whose type is the same as the pointer's base type, and sets the value of the pointer variable to point to the new dynamic variable. NEW is the only way to create a new pointer value, and the only way to create a dynamic variable.

So far we have used only the simplest (and most common) way of calling NEW. The complete syntax is

If there is only one parameter, `NEW` operates as described in the previous sections. Constants can be passed if the pointer's base type is a variant record type; the next section discusses this technique.

### Dynamic Records with Specified Variants

If you are creating numerous dynamic variables of a record type that has a variant part, you may be able to save space by specifying the variant for each dynamic variable. This is done by passing a constant to `NEW` along with a pointer variable. The constant must be the same as one of the case labels in the variant part. The constant specifies which variant is to be used by this particular dynamic record.

The effect is that the space allocated for the dynamic record is only large enough for the specified variant. Note that this is an exception to the usual rule that the space occupied by any record variable with a variant part is large enough for the largest variant.



The constant that specifies the variant is not assigned to the dynamic record's tag field. The program must make this assignment explicitly after the dynamic record is created (assuming that there is a tag field).

Also, observe the following cautions when accessing the dynamic record; if you do not, you may inadvertently destroy information in another record.

- You should not try to change the variant of the record.
- You should not make an assignment to the record as a whole. You can freely make assignments to fields within the record, as long as the fields do not belong to a different variant.
- You should not reference a field that does not belong to the variant you have specified.

To see how all this works, consider an example. Suppose that we have the declarations

```

TYPE ARRAYSIZE = (SMALL, BIG);
SMALLARRAY = ARRAY [0..9] OF REAL;
BIGARRAY = ARRAY [0..99] OF REAL;
VRPTR = ^VREC;
VREC = RECORD
    LINK: VRPTR;
    CASE WHATSIZE: ARRAYSIZE OF
        SMALL: (MEANDATA: SMALLARRAY);
        BIG: (RAWDATA: BIGARRAY)
    END;

VAR INRECORD: RECORD CASE WHATSIZE: ARRAYSIZE OF
    SMALL: (MEANDATA: SMALLARRAY);
    BIG: (RAWDATA: BIGARRAY)
    END;
    HEAD, CURRENT: VRPTR;

```

The program proceeds as in the previous example to create dynamic records and load them with new array values from `INRECORD`; for each new dynamic record, this could be done as follows:

```

NEW(CURRENT^.LINK);
CURRENT := CURRENT^.LINK;
CASE INRECORD.WHATSIZ OF
    SMALL: CURRENT^.MEANDATA := INRECORD.MEANDATA;
    BIG: CURRENT^.RAWDATA := INRECORD.RAWDATA
END;
CURRENT^.WHATSIZ := INRECORD.WHATSIZ;
CURRENT^.LINK := NIL

```

This is just like the previous example, except that the `CASE` statement is needed to check what size array is contained in `INRECORD` and make the appropriate assignment; and of course the tag field must also be assigned.

But the first statement, `NEW(CURRENT^.LINK)`, causes the new dynamic variable to be big enough to contain an array of 100 real values, even if only an array of 10 values is going to be assigned to it. If the array size in this particular dynamic variable is not going to change, this is a waste of space. Instead, we write

```

CASE INRECORD.WHATSIZE OF
  SMALL: BEGIN
    {Create & load small variant of dynamic record;}
    NEW(CURRENT^.LINK, SMALL);
    CURRENT := CURRENT^.LINK;
    CURRENT^.MEANDATA := INRECORD.MEANDATA
  END
  BIG: BEGIN
    {Create & load big variant of dynamic record;}
    NEW(CURRENT^.LINK, BIG);
    CURRENT := CURRENT^.LINK;
    CURRENT^.RAWDATA := INRECORD.RAWDATA
  END
END;
CURRENT^.WHATSIZE := INRECORD.WHATSIZE;
CURRENT^.LINK := NIL

```

Now each dynamic record will occupy only the space it needs to contain the data actually assigned to it.

The syntax for calling NEW allows for more than one constant; this is because a record type can have more than one variant part (nested inside one another). You can specify the variant for each variant part in the record; the sequence of constants in the NEW call is matched with the sequence of variant parts in the record type declaration.

You can supply fewer constants than the number of variant parts; the constants supplied are matched with the variant parts as far as possible, and the remaining variant parts are left unspecified (thus allowing enough space for the largest possible variant).

## MEMAVAIL

In working with dynamic variables, it may be necessary to check the amount of available memory before calling NEW to create a new dynamic variable. The MEMAVAIL function returns the number of two-byte words of memory that are guaranteed to be currently available for program data. It can be used as in the following example:

```

TYPE BIGARRAY = ARRAY[0..99, 0..12] OF INTEGER;
...
VAR APTR: ^BIGARRAY;
...
IF 2*MEMAVAIL > SIZEOF(BIGARRAY) THEN NEW(APTR)
ELSE WRITELN('Help, I'm running out of room!');

```

Note that the value returned by MEMAVAIL is multiplied by 2 to convert from words to bytes, since the value returned by SIZEOF(BIGARRAY) is the size in bytes of a variable of type BIGARRAY. The SIZEOF function is described in Chapter 13.



The system, when reading in the directory of an Apple II formatted diskette, allocates approximately 2,000 bytes in program memory for the directory. After the directory is read, MEMAVAIL will indicate that you have 2,000 fewer bytes available. This space is automatically freed for use when you issue a NEW or RELEASE procedure call. You can also cause the space to be freed, without any other effect on your program, by calling MARK.

## MARK and RELEASE

Pascal as originally defined by Jensen and Wirth has a procedure called DISPOSE. This procedure is not provided in Apple III Pascal. Instead, the MARK and RELEASE procedures are used for returning dynamic memory allocations to the system. Note that MARK and RELEASE do not provide exactly the same capability as DISPOSE; programs using DISPOSE require some rewriting for use on the Apple III.

When a Pascal program starts running, there is an area of memory that is unused. When a dynamic variable is created by NEW, the space allocated to the dynamic variable is at the beginning of unused memory. Each subsequent dynamic variable is allocated space just after the previous dynamic variable.

Thus while the program is running, there is a sequence of dynamic variables which are physically laid out in the order in which they were created. Note that this is not necessarily the order in which the NEW calls are written in the source program; it is the order in which they are actually executed.

The MARK procedure allows you to mark a particular point in the sequence. After this the program can create more dynamic variables. The RELEASE procedure releases the space occupied by these dynamic variables; the space can then be re-used for dynamic variables created after the RELEASE call.

MARK takes a pointer of any type as its only parameter, and so does RELEASE. The forms are

```
MARK ( XXX )
RELEASE ( XXX )
```

where XXX is a pointer variable.

MARK works by making XXX point to the beginning of available unused space. This can be thought of as "marking" the existing space allocation.

RELEASE works by restoring the space allocation that is "marked" by the current value of XXX. That is, RELEASE causes the system to consider that the available unused space begins at the location pointed to by XXX. The effect is to throw away all dynamic variables created since the last time MARK was called with the same variable as its parameter. The chronology is that of the running program, not necessarily the same as the sequence of statements in the program source.



Only the beginning of available space is marked. The end of available space may also change dynamically as the program runs, because of memory usage by the system. The MEMAVAIL function can be used to check the minimum amount of space actually available at any time.

The use of a pointer variable in conjunction with MARK and RELEASE means that a number of marks can be made by calling MARK at different points in the program with different pointer variables. RELEASE can then be called at various other points to release space back to various different marks. The following program fragment is a simple example:

```
VAR MARKER1, MARKER2: ^INTEGER;
...

PROCEDURE ONE;
BEGIN
  {This procedure creates dynamic variables}
END;

PROCEDURE TWO;
BEGIN
  {This procedure creates dynamic variables}
END;

PROCEDURE THREE;
BEGIN
  {This procedure creates dynamic variables}
END;

BEGIN {Main program}
  REPEAT
    {Before calling ONE, mark the existing allocation.}
    MARK(MARKER1);
    ONE;
    {Before calling TWO, mark the existing allocation.}
    MARK(MARKER2);
    TWO;
    {Now we need to release the space used by TWO (but not by
    ONE), before calling THREE. The following statement
    releases all space dynamically allocated since MARKER2
    was used as parameter for MARK. The chronology is that
    of the running program.}
    RELEASE(MARKER2);
    THREE;
    {Now we need to release all of the dynamically
    allocated space, before repeating. The following
    statement releases all space dynamically allocated
    since MARKER1 was used as parameter for MARK. The
    chronology is that of the running program.}
    RELEASE(MARKER1);
  UNTIL {some condition};
  ...
END.
```



Careless use of MARK and RELEASE can leave dangling pointers, which do not point to any useable data. This can lead to inadvertent destruction of data.

---

**10**

***Introduction to Files and I/O***







This chapter assumes that you are familiar with the Filer and with the conventions of pathnames. When a pathname is used in a Pascal program, all conventions are as described in the Introduction, Filer, and Editor manual (chapter on the Filer) except that wildcard characters are not allowed.

This chapter introduces the basic concepts of Pascal files, including the declaration of files in a program. Next it presents a brief overview of the I/O facilities of Apple III Pascal. The remainder of the chapter covers I/O operations on typed files.

## Files

A Pascal file is a special kind of structured variable. A file variable resembles an array, in that it consists of a sequence of distinct variable components, all of the same type. However, the number of components is unknown and they are not accessed by indexing but via the processes called input and output, or I/O.

### External Files

To use a file variable, it must be associated with an external file. An external file is a peripheral device, or a named diskette file. The Pascal program does not manage these devices directly; instead the built-in I/O procedures send requests to the SOS device drivers, which manage the external devices and transfer data between external devices and the program in a very specific manner.

The Pascal programmer need not be concerned with details of device management; however in Chapter 12 we will see procedures for direct device-oriented I/O. The communication between the program and the SOS device drivers is performed automatically by the built-in input and output procedures.

There are three categories of external files:

- Character devices, also called non-block-structured devices. These include the console, printers, the graphics screen, the audio generator, and any other

devices whose input and output are in the form of a stream of ASCII characters (or individual bytes of data). For each of these devices there is a SOS driver, e.g., .CONSOLE, .PRINTER, .SILENTYPE, .GRAFIX, and .AUDIO. You can use these for I/O by giving the driver name as the pathname (you can also use Pascal unit names or numbers; see Appendix J).

- Block-structured devices. These are devices, such as diskette drives, that store blocks of data. Other mass-storage devices would also be in this category. These also have their own SOS drivers (.D1, .D2, etc.). Chapter 12 describes methods of using these devices directly; more commonly they are considered as containers for stored files.
- Stored files on block-structured devices, e.g., diskette files. These are the files that appear in the directories for diskettes. You can use these for I/O by giving a pathname that specifies a diskette volume name and a local filename. (You can also use the SOS device driver name, a Pascal unit name, or a Pascal unit number instead of the diskette volume name; see Appendix J.)

In this chapter and the next we are concerned with character devices and named files. For the most part, these two kinds of files are handled identically; the few cases where there are differences in special-character handling are described as they come up.

### File Variables

The most important feature of a file variable is that its values are not generally in memory. Instead, they exist outside the program as the contents of an external file. However, an 1,100-byte area of memory is allocated for every declared file in a currently active procedure.

A file variable is declared along with other variables, using a file type. In this chapter and the next we are concerned with typed files; "block" files are covered in Chapter 12. The syntax of a file type (for a typed file) is

file type (for typed file)

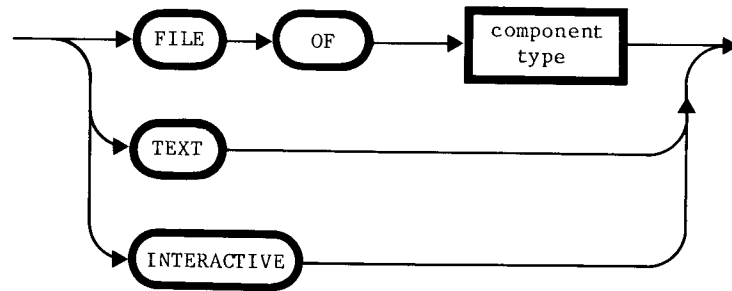

where the component type can be any type except a file type. TEXT and INTERACTIVE are built-in file types: TEXT is exactly equivalent to FILE OF CHAR, and INTERACTIVE is a special type described in the next chapter.



External diskette files also have "types," which are independent of Pascal file variable types. One of these external file types is called "Textfile". Note that the file variable type TEXT and the external file type "Textfile" are two different things; a file variable of type TEXT may or may not correspond to an external file of type "Textfile." See Chapter 12 for a description of the external "Textfile" type and what it means to a Pascal program.

Remember that the file variable type determines how the Pascal program will interpret the file's contents. The external type of the file determines how the data are actually stored and formatted on the diskette. As a general rule, the external file type makes no difference to a Pascal program that uses the I/O mechanisms described in this chapter and in Chapter 11. The external file type "Textfile" affects random access with the SEEK procedure (explained further on in this chapter) and in block I/O and device-oriented I/O (see Chapter 12).

The components of a file variable are usually called logical records or simply "records," although their type is not necessarily a record type. For example, the declarations

```

VAR INTVALS: FILE OF INTEGER;
    REALVALS: FILE OF REAL;
    COMPVALS: FILE OF RECORD
        I: INTEGER;
        R: REAL
    END;
  
```

create three file variables. INTVALS is a file variable whose records are integer values, and REALVALS is a file variable whose records are real values. COMPVALS is a file variable whose records are actually of a record type, with an integer value and a real value in each record.

### Using a File

This chapter goes into I/O mechanisms in detail, but first we present a brief description of how a program can store values in a diskette file and how they can be retrieved later.

The RESET and REWRITE procedures, described in detail further on, serve to associate a file variable with a specific pathname; if the pathname refers to a diskette drive or a named diskette, the file variable can be associated with a specific named file on the diskette. Once this has been done, the file is said to be "open" and its records can be accessed. For example, suppose that we have the declarations shown above and that a diskette drive contains a diskette named /VALUES. If we write

```
REWRITE (INTVALS, '/VALUES/INTEGERS.DATA')
```

the effect is to associate the file variable INTVALS with the diskette file /VALUES/INTEGERS.DATA. Because we opened the file with REWRITE instead of RESET, SOS automatically creates a diskette file named INTEGERS.DATA on diskette /VALUES. (If there is already a diskette file by that name, SOS will later delete either the old diskette file or the new one, depending on how the program "closes" the file.)

REWRITE also prepares for I/O by defining a buffer variable called INTVALS^. This is an integer variable, since INTVALS is a FILE OF INTEGER. Suppose that the program contains an integer variable XYZ, and we want to write the value of XYZ into INTVALS as the first record of the file variable. We write

```
INTVALS^ := XYZ;
PUT(INTVALS)
```

The first statement assigns the value of XYZ to the buffer variable, and the PUT procedure (via SOS) writes the value out as the first record of the diskette file /VALUES/INTEGERS.DATA. The next PUT(INTVALS) call will write out the buffer variable to the second record of /VALUES/INTEGERS.DATA, and each subsequent PUT(INTVALS) writes the next record in sequence.

When the program is through using the INTVALS file, it closes it:

```
CLOSE(INTVALS, LOCK)
```

The LOCK option tells SOS to make the new /VALUES/INTEGERS.DATA diskette file permanent.

Now we have a permanent diskette file containing some unspecified number of integer values. Suppose that another program needs to access this data. Again we must declare a file variable of appropriate type:

```
VAR INDATA: FILE OF INTEGER;
```

Although this file variable has a different name from the one used previously, it can of course be associated with the same diskette file. In the new program, we open the file with RESET instead of REWRITE:

```
RESET(INDATA, '/VALUES/INTEGERS.DATA')
```

Unlike REWRITE, RESET requires that the external file already exist. (If it does not, the program is halted with an error message.) RESET creates a buffer variable of type integer (named INDATA^) and, unlike REWRITE, it loads the buffer variable with the first value in the diskette file. Suppose that we want to assign this value to an integer variable named ABC, and then have the next value from the diskette file loaded into the buffer variable. We write

```
ABC := INDATA^;  
GET(INDATA)
```

The effect of GET is always to load the next record from the external file into the buffer variable (by issuing a request to SOS).

Note the parallelism between output and input. For output we opened the file with REWRITE, and then each value was written out by

- Using the buffer variable (by assigning the value to it).
- Calling PUT with the name of the file variable as its parameter.

For input we opened the file with RESET, and then each value was read in by

- Using the value of the buffer variable (assigning it to another variable in this case).
- Calling GET with the name of the file variable as its parameter.

Before proceeding to a detailed description of the built-in I/O procedures for typed files, we give an overview of all the file I/O facilities provided in Apple III Pascal.

## **Overview of Apple III Pascal I/O Facilities**

Apple III Pascal I/O facilities fall into four different categories:

- Device-oriented I/O (covered in Chapter 12): The procedures UNITREAD, UNITWRITE, UNITBUSY, UNITWAIT, UNITSTATUS, and UNITCLEAR are the lowest level of control. They allow a Pascal program to transfer a specified number of consecutive bytes between memory and a device. They are not controlled by SOS pathnames, directories, etc., but merely use unit numbers and (for diskette drives) block numbers.
- Block I/O (covered in Chapter 12): The BLOCKREAD and BLOCKWRITE functions provide I/O for untyped files. They make use of SOS pathnames and directories, but they consider a file to be merely a sequence of 512-byte blocks--not a sequence of logical records of a particular type.

- Text I/O (covered in Chapter 11): The READ, READLN, WRITE, and WRITELN procedures provide text-oriented I/O for files of characters. The PAGE procedure writes a form feed control character into a file of characters. The EOLN function provides an indication of when the end of a text line has been reached.
- Typed file I/O (covered in the remainder of this chapter): The GET, PUT, and SEEK procedures treat a file as a sequence of logical records. GET and PUT provide transfers between individual file records and the file's buffer variable, and SEEK causes the next GET or PUT to access a specified record. The EOF function provides an indication of when the end of the file has been reached.

## Typed File I/O

This section is concerned with typed files--that is, files that are considered as a sequence of logical records. Typed files are declared as shown at the beginning of this chapter. Such file variables are generally associated with diskette files, and all of the examples given here use diskette files. The essential mechanisms for I/O operations with typed files are the GET and PUT procedures.

For files where the logical records are characters (types FILE OF CHAR, TEXT, and INTERACTIVE), Pascal also provides specialized text-oriented I/O as explained in the next chapter. Character files can be accessed either with the text I/O procedures or with GET and PUT as described below; however there are some special considerations for INTERACTIVE files which are discussed in the next chapter.



If an I/O operation is unsuccessful, the system will normally terminate program execution with an error message. However, there is a Compiler option to disable this feature, as described in Appendix F. The IORESULT function can then allow the program itself to check on the status of the most recent I/O operation and take appropriate action.

## The REWRITE Procedure

This procedure opens a new file--i.e., it creates an external file, associates it with a file variable, and creates a buffer variable. The file can then be used for input and output. REWRITE is normally used for output. The form for calling REWRITE is

```
REWRITE ( FILEID, PATHNAME )
```

where FILEID is the identifier of a file variable, and PATHNAME is an expression with a string value. The string value is the pathname of the external file.

If the pathname specifies a character device, then the file is simply opened. If the pathname specifies a diskette file, REWRITE creates a new file and opens it. If the pathname is the same as that of an existing diskette file, a new diskette file is created with the same name; one or the other will later be deleted as described below under CLOSE.

If the file is a diskette file and is already open--i.e., if the file identifier corresponds to a currently open file--an I/O error occurs (see IORESULT below). The file remains open.

However, any external file that has been opened can legally be opened again via REWRITE with a different file variable.

An example showing the use of REWRITE in a program follows the description of GET and PUT later in this chapter.

## The RESET Procedure

This procedure, like REWRITE, opens a file which can then be used for input and output. RESET is normally used for input. Unlike REWRITE, RESET requires that the external file already exist. The syntax for calling RESET is:

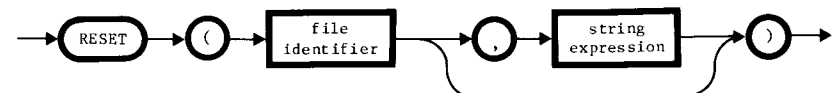

Note that the string expression may be omitted; this is explained below. The string value is the pathname of the external file.

If there is no file with this name, an I/O error occurs (see IORESULT, below).

If the file is a diskette file and is already open--i.e., if either the file identifier or the diskette-file pathname corresponds to a currently open file--an I/O error occurs (see IORESULT below). The file remains open. However, if a non-diskette file has been opened, it can legally be opened again with a different file variable.

RESET automatically performs a GET action--that is, it loads the first record of the file into the file's buffer variable, and the first explicit GET or PUT in the program will access the second record. Thus, resetting a non-interactive file to the console requires the user to type a character when the RESET is executed. If the file is INTERACTIVE (see next chapter) no GET is performed.

Note that RESETTING a non-INTERACTIVE file to an output-only device, such as .PRINTER, may cause a run-time error as a result of the automatic GET caused by the RESET. In this case, use REWRITE to open the file.

When a file opened with RESET is used for output, only the file records actually written are affected.

RESET can also be called without a pathname if the file is already open. The effect is simply to "reopen" the file, using the same external file. This allows the program to go back to the beginning of the file and re-access records. The buffer variable contains the value of the first record, and the next explicit GET or PUT will move the buffer variable to the second record. In the case of the console, the primary use of RESET without a pathname is to clear end-of-file.

An example showing the use of RESET in a program follows the description of GET and PUT later in this chapter.

## The CLOSE Procedure

This procedure closes a file which was previously opened with RESET or REWRITE. The syntax for calling CLOSE is

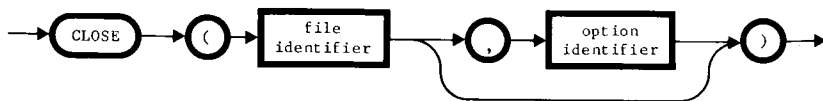

where the option identifier, if used, may be any one of the following predefined identifiers. If no option identifier is used, the effect is the same as using the NORMAL option.

**NORMAL** -- A normal close is done; i.e., CLOSE simply sets the file state to closed. If the file was opened using REWRITE and the external file is a diskette file, it is deleted from the directory.

**LOCK** -- If the external file is a diskette file and was opened with REWRITE, it is made permanent in the diskette's directory; otherwise a NORMAL close is done. If the file was opened with a REWRITE and the pathname matches an existing diskette file, the old file is deleted.

**WPROTECT** -- Same as LOCK, but the external file is made write-protected. Any future attempt to write to the file, delete it, or rename it (either with a file I/O procedure or from the command level) will cause an I/O error (see IORESULT below). However, note that the file is not protected against the UNITWRITE procedure (see Chapter 12).

**UNPROTECT** -- Same as LOCK, but write-protection is cancelled if the file was opened with a RESET.

**PURGE** -- If the external file is a diskette file, it is deleted from the directory (unless write-protected). In the special case of a diskette file that already exists and is opened with REWRITE, the original file remains in the directory, unchanged. If the external file is not a diskette file, the associated unit will go off-line.

**CRUNCH** -- This is like LOCK except that it locks the end-of-file to the point of last access; i.e., everything after the last record accessed is thrown away.

All CLOSEs regardless of the option will mark the file closed and will make the file buffer variable undefined. CLOSE on a closed file causes no action.

If a program terminates with a file open (i.e., if CLOSE is omitted), the system automatically closes the file with the NORMAL option.



If you open an existing file with RESET and modify the file with any write operation, the contents are immediately changed no matter what CLOSE option you specify.

An example showing the use of CLOSE in a program follows the description of GET and PUT later in this chapter.

### Effect of CLOSE Options

The following diagrams show the result of closing a file which was opened with REWRITE or RESET, depending on the CLOSE option selected.

diagram: opened with rewrite

CLOSE Option File		Opened with REWRITE						
		NORMAL	LOCK	WPROTECT	UNPROTECT	PURGE	CRUNCH	
No Old File		Pathname not entered; contents thrown away	Pathname entered; contents kept	Pathname entered & protected; contents kept	Pathname entered; contents kept	Pathname not entered; contents thrown away	Pathname entered; contents truncated and kept	
	Old Unprotected File Exists		Contents thrown away	Contents kept	Pathname protected; contents kept	Contents kept	Contents thrown away	Contents truncated and kept
		Contents kept	Contents deleted	Contents deleted	Contents deleted	Contents kept	Contents deleted	Old file results
Old Protected File Exists		Contents thrown away	Run-time error	Run-time error	Run-time error	Contents thrown away	Run-time error	New file results
		← Contents kept →						Old file result

Example: If an old unprotected file is opened with REWRITE and closed with CRUNCH, the new file contents are truncated and kept while the old file contents are deleted.

diagram: opened with reset

CLOSE Option File							
		NORMAL	LOCK	WPROTECT	UNPROTECT	PURGE	CRUNCH
No Old File		← Run-time I/O error upon RESET; file never opened →					
Old Unprotected File Exists		Contents kept	Contents kept	Pathname protected; contents kept	Contents kept	Pathname & contents deleted	Contents truncated & kept
		Contents kept	Contents kept	Contents kept	Pathname unprotected; contents kept	Run-time error	Run-time error unless at EOF



To determine if an existing file is write-protected:

- reset the file;
- do a read;
- reset the file again (to go to the beginning);
- try to write the information you just read.

If the file was write-protected, the write will fail; otherwise the write will succeed and leave the file unchanged.



To remove the protection from a write-protected file, reset the file and then close it with the UNPROTECT option.

## The EOF Function

This function returns a BOOLEAN value to indicate whether the end of a specified file has been reached. When EOF is true, nothing more can be read from the file. The syntax for calling EOF is

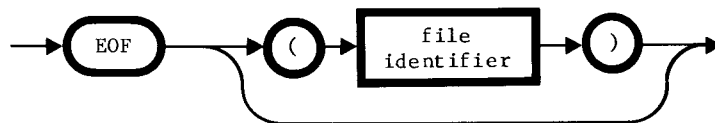

If no file identifier is used, the predefined file INPUT (see next chapter) is assumed.

EOF is false immediately after the file is opened if the file has any records in it; EOF is true on a closed file. Whenever EOF is true for a particular file, the value of the file's buffer variable is undefined.

After an input operation, EOF is true if the operation attempted to access a record that is after the end of the file. When this is the case, the value of the file's buffer variable is not defined.

After an output operation, EOF is true if the file cannot be expanded to accommodate the output (because of limited diskette space, for example). However, note that this will generally be considered an I/O error, causing the program to halt with an

error message before EOF can be checked.

An example showing the use of EOF in a program follows the description of GET and PUT below.

## The GET and PUT Procedures

These procedures are used to read or write one logical record from or to a typed file. The forms are

```
GET ( FILEID )
```

```
PUT ( FILEID )
```

where FILEID is the identifier of a file, which must be open.

GET moves the contents of the next external file record into the file's buffer variable. Note that immediately after RESET, the contents of the first external file record are already in the buffer variable and the "next" record is the second record.



There is one special case: when GET is used with a file of type TEXT or INTERACTIVE and a "return" character (ASCII 13) is read, the character is converted to a space (ASCII 32). Also, the function EOLN (see next chapter) will then return TRUE.

See the last section of this chapter for a note on special handling of control characters.

PUT puts the contents of the file's buffer variable into the next external file record. If the file was opened with REWRITE, this means that the "next" record is created; if it was opened with RESET, the "next" record already exists and is overwritten.

Note that when a non-INTERACTIVE file is opened with RESET, there is apparently no way for PUT to access the first record of the external file. This is because immediately after the RESET the "next" record is the second one. The SEEK procedure (see below) provides a way around this limitation.

After a GET or PUT, the next GET or PUT with the same file identifier will access the next external file record in sequence.

With diskette files, the actual physical diskette access may not occur until the next time the physically associated block of the diskette is no longer considered the current working block. The kinds of operation which tend to force the block to be written are: a SEEK to elsewhere in the file, a RESET, and CLOSE. Successive GETs or PUTs to the file will cause the physical I/O to happen when the block boundaries are crossed.

The following two example programs illustrate the use of REWRITE, RESET, CLOSE, EOF, GET, and PUT. The first program creates a new file of component type REAL, with the pathname /WTS/REAL.DATA, and puts ten REAL values into it. The values are supplied by the user.

To obtain the values, the program uses a WRITE to display a prompt on the screen and a READ to accept the value typed by the user. READ and WRITE are described in detail in the next chapter.

```
PROGRAM MAKEFILE;

VAR F: FILE OF REAL;
    I: INTEGER;

BEGIN
  {Open with REWRITE since this is a new file.}
  REWRITE(F, '/WTS/REAL.DATA');
  {Read 10 numbers and store them in the file.}
  FOR I:=1 TO 10 DO BEGIN
    {Put a prompt on the screen.}
    WRITE('-->');
    {Read number from keyboard into buffer variable.}
    READ(F^);
    {Store the number in the file.}
    PUT(F)
  END;
  {Close the file and lock it.}
  CLOSE(F, LOCK)
END.
```

The second program reads values from the file created by the first program, and displays them on the screen.

```
PROGRAM READFILE;

VAR F: FILE OF REAL;
```

```
BEGIN
  {Open with RESET since we want to read the file}
  RESET(F, '/WTS/REAL.DATA');
  {First number is in F^. While EOF remains false, display
  each number and get the next.}
  WHILE NOT EOF(F) DO BEGIN
    {Display the current number on the screen}
    Writeln(F^);
    {Get the next number}
    GET(F)
    {If there was no next number, EOF is now true.}
  END;
  {Close the file}
  CLOSE(F)
END.
```

Note that these programs offer no flexibility as to the pathname of the file. The next example will show how to let the program's user specify the pathname of the external file to be used.

### The IORESULT Function

This built-in function takes no parameters and returns an integer value which reflects the status of the last completed I/O operation:

0	No error; normal I/O completion
2	Bad unit number
3	Illegal operation (e.g., read from .PRINTER)
5	Lost unit--no longer on line
6	Lost file--file is no longer in directory
7	Illegal pathname
8	No room--insufficient space on diskette
9	No unit--unit is not on line
10	No such file in specified directory
11	Duplicate pathname
12	Attempt to open an already open file
13	Attempt to access a closed file
14	Bad input format--error in reading number
15	Ring buffer overflow--input arriving too fast
16	Write-protect error--diskette is protected
19	Too many files open for system to handle
48..63	(SOS) Device-specific error
64	Device error--bad address or data on diskette



65	(SOS) Too many character files open
66	(SOS) Too many block files open
73	(SOS) Directory full
74	(SOS) Incompatible file format
81	(SOS) Volume format neither SOS nor Apple II
84	(SOS) Out of memory for SOS system buffer
87	(SOS) Duplicate volume error

The (SOS) notation indicates an error reported by SOS as opposed to the Pascal system. There are some other SOS I/O errors besides those shown above; see Appendix J for a complete table.

In normal operation, the Compiler will generate code to perform run-time checks after each I/O operation except UNITREAD or UNITWRITE. This causes the program to be halted with a run-time error message on a bad I/O operation. Therefore if you want to check IORESULT with your own code in the program, you must disable run-time I/O checking by using a Compiler option.

Compiler options are commands to the Compiler, embedded in the program text. The complete set of options is described in Appendix F, but here we are concerned with just two: the text

```
{ $IOCHECK- }
```

disables run-time I/O checking, and the text

```
{ $IOCHECK+ }
```

enables it. The following sample program illustrates the use of these options. It allows the user to add new records to a file containing information about people's birthdays. If the external file specified by the user does not already exist, the program detects this fact by using IORESULT. If IORESULT does not return a  $\emptyset$  value, the program uses REWRITE instead of RESET to create the external file.

```
PROGRAM ADDRERCORDS;
  {Adds records to a birthday file. Creates the file if
  necessary.}
VAR
  INCHAR: CHAR;
  PATHNAME: STRING;
  BIRTHDAYS: FILE OF RECORD
      NAME: STRING[20];
      DAY, MONTH: INTEGER;
END;

BEGIN

  {Obtain pathname.}
  WRITE('Enter pathname: ');
  READLN(PATHNAME);

  {Use RESET to preserve existing contents of file; if
  it doesn't exist, then use REWRITE to create it.}
  { $IOCHECK- } {This turns off I/O error checking, so
  if RESET doesn't work the program doesn't
  get halted. Then it can use IORESULT to
  check for error.}
  RESET(BIRTHDAYS, PATHNAME);
  { $IOCHECK+ } {This turns I/O error checking back on.}
  IF IORESULT<> $\emptyset$  THEN REWRITE(BIRTHDAYS, PATHNAME);

  {Go to end of file with repeated GETs.}
  WHILE NOT EOF(BIRTHDAYS) DO GET(BIRTHDAYS);
```

```

{Repeat the following until user doesn't want to make
any more new records.}
REPEAT
  {Find out if user wants to make a new record.}
  WRITE('Make a new record? (Type y or n): ');
  READ(INCHAR);
  IF INCHAR IN ['y', 'Y'] THEN BEGIN
    {Create the new record}
    WITH BIRTHDAYS^ DO BEGIN
      WRITELN;
      WRITE('Enter name: ');
      READLN(NAME);
      WRITE('Enter day: ');
      READLN(DAY);
      WRITE('Enter month: ');
      READLN(MONTH)
    END;
    {PUT the new record into file.}
    PUT(BIRTHDAYS)
  END {of "if inchar in ['y', 'Y']"}
UNTIL NOT (INCHAR IN ['y', 'Y']);

CLOSE(BIRTHDAYS, LOCK) {Must use LOCK in case REWRITE
                        was used to open.}
END.

```



Be careful if you disable I/O error checking with the {\$IOCHECK-} option. You will not be informed of the failure of any I/O operation that is performed while I/O error checking is disabled.



Every I/O operation potentially changes IORESULT. Therefore, if you want to write out the value of IORESULT for a previous I/O operation, you should save it in an auxiliary variable and then write the auxiliary variable.

## Random Access

### Introduction

So far, we have only discussed sequential access to files: after accessing any particular file record, the next record accessed is the next one in sequence. In random access, a program can access any existing file record at any time, without regard to the sequence of records in the file. Note that this means a given record can be accessed repeatedly, without the need to RESET the file. For example, a program might first read all records of a diskette file sequentially, and then alter the 8th, 2nd, 10th, and 5th records in that order.

This is done by using the SEEK procedure with record numbers. The sequence of records in a file can be regarded as a numbered sequence: the first record in the file is record number 0, the next is record number 1, and so forth.



Incidentally, the terms "random file" and "sequential file" are commonly used but misleading. Random and sequential are two methods for accessing files--not two kinds of files. Any typed file can be accessed randomly or sequentially or both ways. Whether it makes sense to use a particular kind of access depends on the program and on the contents of the file records.

### The SEEK Procedure

The SEEK procedure allows the program to access any specified record in a file, and this provides random access to file records. The form for calling SEEK is

```
SEEK ( FILEID, RECNUM )
```

where FILEID is the identifier of a file and RECNUM is an expression with an integer value that specifies a record number in the file. Note that records in files are numbered from 0.

SEEK affects the action of the next GET or PUT from/to the file, forcing it to access the specified file record instead of the "next" record. SEEK does not affect the file's buffer variable.

The file should be a file on a diskette or other block-structured device. It should not be a character device, nor should it be declared as a file of type TEXT, INTERACTIVE, or FILE OF CHAR.



If the file is a character device or is of the type TEXT, INTERACTIVE, or FILE OF CHAR, SEEK does nothing.

A GET or PUT must be executed between SEEK calls since two SEeks in a row may cause unpredictable results. Immediately after a SEEK, EOF will return false; a following GET or PUT will cause EOF to return the appropriate value.



The record number specified in a SEEK call is not checked for validity. If the number is not the number of a record in the file and the program tries to GET the specified record, the value of the buffer variable becomes undefined and EOF becomes true. In fact, this is a way to check the validity of a record number: SEEK it and then do a GET. If EOF is false after the GET then the number was valid.

But if SEEK is called with an invalid record number and the program tries to do a PUT to the specified record, the result of the PUT is unpredictable and may cause an I/O error. Therefore if there is any doubt about the validity of a record number, the program should make sure that it is valid.



The standard system library file SYSTEM.LIBRARY contains a unit named PASCALIO. The SEEK procedure cannot be executed unless this unit is available in a library at the start of execution.

The following sample program demonstrates the use of SEEK to randomly access and update records in a file. It uses a file of birthday information created by the program shown in the previous section, and it allows the user to correct existing records in this file.

```
PROGRAM RANDOMACCESS;
{Allows update of any selected record in birthday file.}
VAR
  RECNUMBER: INTEGER;
  FNAME: STRING;
  BIRTHDAYS: FILE OF RECORD
    NAME: STRING[20];
    DAY, MONTH: INTEGER;
END;

BEGIN
  {Obtain filename.}
  WRITE('Enter filename: ');
  READLN(FNAME);
  {Use RESET to preserve existing contents of file; if
  it doesn't exist, complain and stop the program.}
  {$IOCHECK-} {This turns off I/O error checking.}
  RESET(BIRTHDAYS, FNAME);
  {$IOCHECK+} {This turns I/O error checking back on.}
  IF IORESULT<>0 THEN BEGIN
    Writeln('File not found. ');
    EXIT(PROGRAM)
  END;

  {Repeat the following until user types a negative record
  number, or until there is not enough diskette space for
  new records.}
  REPEAT
    {Obtain record number; fall through to end if user types
    negative record number.}
    WRITE('Enter record number (negative to quit): ');
    READLN(RECNUMBER);
    IF RECNUMBER >= 0 THEN BEGIN

      {GET the specified record}
      SEEK(BIRTHDAYS, RECNUMBER);
      GET(BIRTHDAYS);
```

```

{If record number was invalid, EOF(BIRTHDAYS) will now
be true, so skip the rest and get another number.}
IF NOT EOF(BIRTHDAYS) THEN BEGIN
  {Update the record}
  WITH BIRTHDAYS^ DO BEGIN
    WRITELN('Name is ', NAME);
    WRITE('Enter correct name: ');
    READLN(NAME);
    WRITELN('Day is ', DAY);
    WRITE('Enter correct day: ');
    READLN(DAY);
    WRITELN('Month is ', MONTH);
    WRITE('Enter correct month: ');
    READLN(MONTH)
  END;

  {Now SEEK the same record again, since the GET
  advanced the file pointer to the next record after
  it got the current record into BIRTHDAYS^ }

  SEEK(BIRTHDAYS,RECNUMBER);

  {PUT updated record into file.}
  PUT(BIRTHDAYS)
  END {of "if not eof(birthdays)"}
  END {of "if recnumber >= 0"}
  UNTIL RECNUMBER < 0;
  CLOSE(BIRTHDAYS)
END.

```

## Special Handling of Control Characters with GET and PUT

Files of type TEXT or INTERACTIVE are usually accessed with the text I/O procedures described in the next chapter. When GET and PUT are used with files of type TEXT and INTERACTIVE, there are some special considerations for three special control characters, namely

The CR (or "return" or CTRL-M) character, ASCII 13  
 The DLE (or CTRL-P) character, ASCII 16  
 The CTRL-C (or ETX) character, ASCII 3



Because of the special handling of these characters, described below, GET and PUT should not be used for control-character communication with device drivers. Instead, use UNITREAD and UNITWRITE as described in Chapter 12.

The CR character is used in files of characters to mark the end of a line. The special handling is as follows:

- As already mentioned, when this character is read by GET it is converted to a space (ASCII 32).
- When PUT writes the CR character to a diskette file, there is no special action; the CR character is simply written into the file.
- When PUT writes the CR character to a character device a linefeed character (ASCII 10) is automatically written immediately after the CR.

The DLE character is used in textfiles as the first character of a two-character code to represent indentation at the beginning of a line or a sequence of spaces anywhere on a line; this is called a DLE-blank code and is explained in detail at the end of Chapter 12. The special handling is as follows:

- When the DLE character is read by GET, it and the following character are converted to a sequence of spaces (assuming that a sequence of GETs is used for reading). The exception is when GET is used to read from the console; in this case the DLE and the following character are simply read like any other characters.
- When PUT writes the DLE character to a diskette file, there is no special action; the DLE character and the following character are simply written out. However when output is to a character device, the DLE character and the next character following it are converted into a sequence of spaces (see Chapter 12 for details).

The CTRL-C character is used with character devices as an "end-of-text" indicator. The special handling is as follows:

- 
- When the CTRL-C character is read from a diskette file by GET, no special handling occurs; the CTRL-C is read like any other character.
  - When the CTRL-C character is read from a character device by GET, it is converted to a space. EOF and EOLN (see next chapter) will return TRUE.
  - When PUT writes the CTRL-C character, there is no special action; the CTRL-C character is simply written out like any other character. However when output is to the console, this has a special effect as a screen control code. In general, do not write any control character to the console unless you pay careful attention to the section on "Screen Control Codes" in the Standard Device Drivers Handbook.

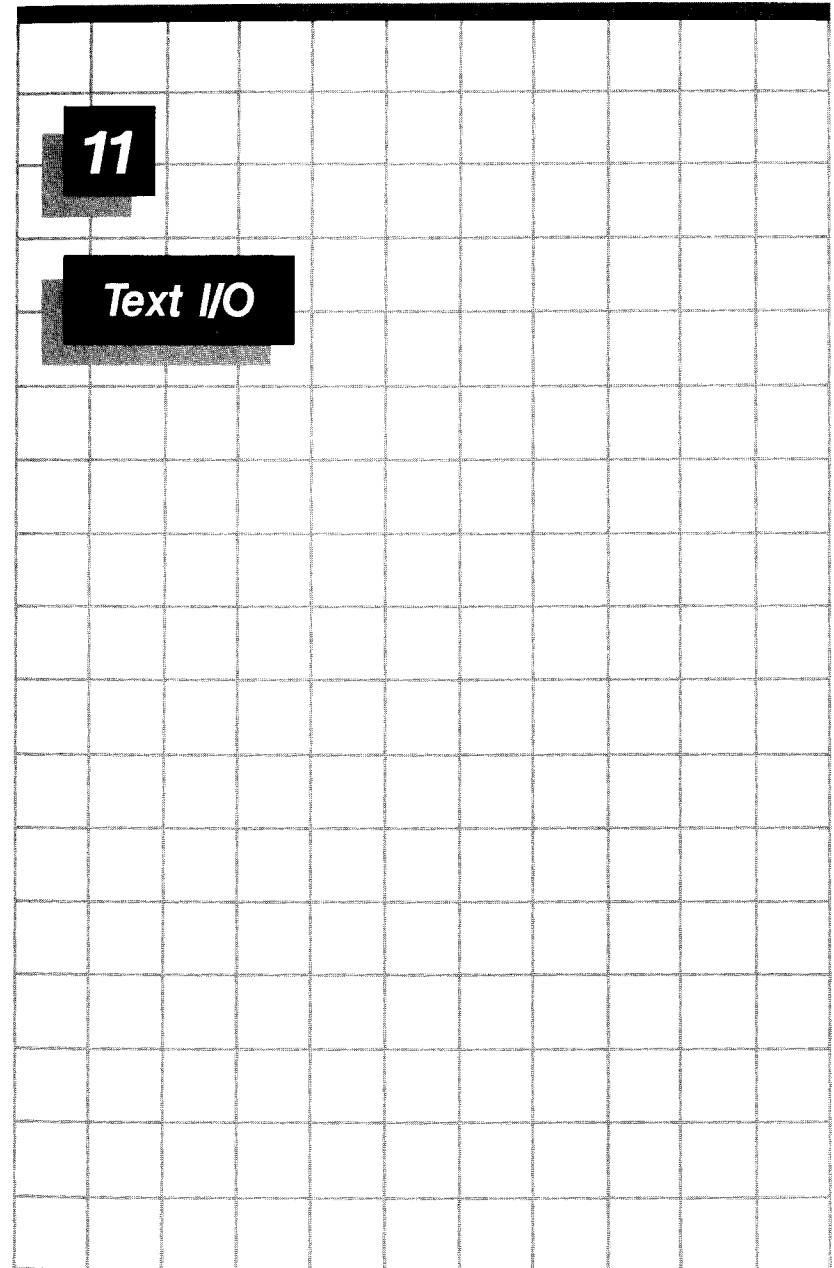

## Introduction

In addition to PUT, GET, and EOF, Apple III Pascal provides the standard procedures READ, READLN, WRITE, WRITELN, EOLN, and PAGE, collectively known as the text I/O procedures.

WRITE, WRITELN, READ, and READLN have already been introduced informally in examples. WRITE and WRITELN have the effect of writing out text. In the examples, they have been used to write text on the screen. The only difference between the two is that WRITE writes only the specified text, while WRITELN writes the specified text so that the next character written will start a new line.

READ and READLN have been used in examples to read text from the keyboard. The difference between the two is that READLN advances to the beginning of the next line after reading, and READ does not.

The EOLN function is used to detect an end-of-line in text input, and the PAGE procedure places a form-feed (ASCII 12) in text output.

These procedures have capabilities beyond what has already been shown; complete details are given in this chapter. Generally, they give Pascal programs a convenient way to treat a file of characters as a sequence of characters organized into lines; the characters within a line can be treated as individual character values or as strings, or interpreted as numeric values (INTEGER or REAL). To support these capabilities, Apple III Pascal has some special features for files of characters.

## Character Files

The text I/O procedures can only be used with files that are declared as character files. A character file is any file whose components are declared to be of type CHAR. Thus the type of a character file can be any one of the following:

FILE OF CHAR  
TEXT  
INTERACTIVE



Note that this definition is not the same as the SOS usage of the term "character file." In this manual, the term is always meant to apply to the Pascal types listed above.

As previously noted, the built-in type TEXT is exactly equivalent to FILE OF CHAR. In the remainder of this chapter, we will refer only to the types TEXT and INTERACTIVE; remember that FILE OF CHAR is the same thing as TEXT.



Various parts of the system that deal with files of characters (such as the Editor and the Compiler) are designed to use files of the external type "Textfile". For most purposes, it is therefore recommended that you use the "Textfile" type for any character files created by your programs. This means that when you create a character file with REWRITE, the pathname should end with the .TEXT suffix.

For the purposes of this chapter, however, the distinction between the "Textfile" type and other external types is unimportant; the text I/O procedures make the special formatting of a "Textfile" invisible to the Pascal program. In particular, this means that Pascal programs can process "Asciifiles" created in BASIC.

## INTERACTIVE Files

The difference between TEXT and INTERACTIVE files is in the way they are handled by the RESET, READ, and READLN procedures.

When a Pascal program READs characters from an existing TEXT file, the program must first open the file with RESET. RESET automatically performs a GET operation: that is, it loads the first character of the file into the file's buffer variable and then advances the file pointer to the next character. A subsequent READ or READLN begins its operation by first taking the character that is already in the buffer variable and then performing a GET.

If the file is of type INTERACTIVE instead of TEXT, the opening RESET does not perform a GET. The buffer variable is undefined and the file pointer points to the first character of the file instead of the second. Therefore, a subsequent READ or READLN begins its operation by first performing a GET and then taking the character that was placed in the buffer variable by the GET. This is the reverse of the READ sequence used with a TEXT file.

There is one primary reason for using the INTERACTIVE type. If a file is not a diskette file but a character device, it is not possible to perform a GET on it until the device has a character ready for input. If RESET tried to do a GET from the keyboard, for example, the program would then have to wait until a character was typed. With the INTERACTIVE type, the program doesn't perform a GET until it is executing a READ or READLN.

Therefore, the type INTERACTIVE is normally used for text I/O with any character device.

### ***Built-In Files***

For convenience in performing console I/O, three files are predeclared. Their identifiers are OUTPUT for output to the screen, and INPUT and KEYBOARD for input from the keyboard. All three of these files are of type INTERACTIVE, and all three are automatically opened via RESET when the Pascal program begins executing.

The difference between INPUT and KEYBOARD is that when INPUT is used to refer to the keyboard, the typed characters are automatically displayed on the screen; when KEYBOARD is used, the characters are not displayed. This allows a Pascal program to have complete control over the screen's response to characters typed by the user.

When the EOF function is used with these files, it behaves in a special way: EOF(KEYBOARD) and EOF(OUTPUT) are never true, and EOF(INPUT) only becomes true when CTRL-C (ASCII 3) is typed and remains true until a RESET is executed.

### ***Using the Procedures and Functions***

The operation of the text I/O procedures is very straightforward when they are used consistently to treat a file as a sequence of

text entities for either input or output. However, difficulties may arise in the following unusual cases:

- When you explicitly use GET, PUT or the file buffer variable in combination with text I/O procedures on the same file variable. (As it turns out, there is rarely any reason to do this.)
- When you mix reading and writing operations on the same file variable. (Instead, you can use one file variable for input and another for output.)

The reason is that the text I/O procedures themselves use GET and PUT in complicated ways, and therefore the exact position in the file can become a question. Specifically, it is sometimes hard to be sure about the following points:

- Exactly what character is the "next" record in a file after a READ or READLN.
- Exactly when EOLN or EOF becomes true.
- Whether the file buffer variable contains the "current" character or the "next" character.

The exact rules are given at the end of this chapter. Note that they depend, in some cases, on whether the file variable is of type TEXT or INTERACTIVE and also on what type of variable is used with READ or READLN.

### ***The EOLN Function***

EOLN is defined only for character files. This function returns a BOOLEAN value to indicate whether the end of a text line has been reached in the input from a specified character file. The syntax is

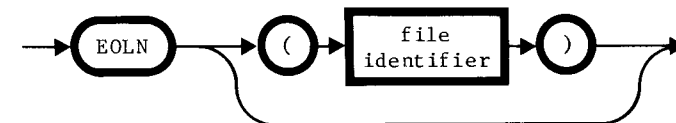

If no file identifier is given, INPUT is assumed.

EOLN returns true on a closed file. It returns false immediately after the file is opened, except in the special case of a file of type TEXT that begins with the RETURN character.

As a rule, EOLN returns true whenever EOF is true. There is only one exception: EOLN never returns true after a READLN operation on an INTERACTIVE file (regardless of whether EOF is true).

For more details on the behavior of EOLN after a READ or READLN, see the descriptions below.

## The READ Procedure

This procedure can be used only on character files. It allows characters, strings, and numeric values to be read from a file without the need for explicit use of GET or explicit reference to the window variable. The syntax for calling READ is

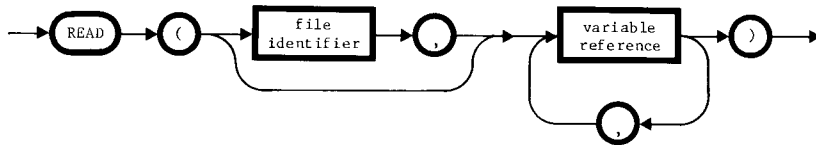

where the file identifier must be that of an open character file. If the file identifier is omitted, the predeclared file INPUT is assumed. Each variable reference may refer to a variable of type CHAR, STRING, INTEGER, LONG INTEGER, or REAL. (But you should use READLN for STRING variables).

READ reads values from the file and assigns them to the variables in sequence.

## READ with a CHAR Variable

For a CHAR variable, READ reads one character from the file and assigns that character to the variable. For example,

```
READ(TSTFIL,INCHAR)
```

(where TSTFIL is a character file and INCHAR is a CHAR variable) reads the next character from TSTFIL and assigns its value to INCHAR.

Special characters are handled as follows:

- Whenever the RETURN character (ASCII 13) is read, it is converted to a space (ASCII 32).
- A DLE-blank code found in a "Textfile" is converted by READ to a sequence of spaces. The exception is when READ is used for input from the console; in this special case a DLE is not converted but simply read like any other character.
- When the CTRL-C character (ASCII 3) is read from a diskette file, there is no special handling; the CTRL-C is read like any other character.
- When the CTRL-C character is read from a character device, it is converted to a space and causes EOF and EOLN to return true.
- Whenever EOF becomes true, the value assigned to the CHAR variable is not defined.

After the READ, the next READ or READLN will always start with the character immediately following the one just read.

The workings of EOLN and EOF depend on whether the file is of type TEXT or INTERACTIVE:

- For a TEXT file, EOF is true when the last text character in the file has been read. EOLN is true when the last text character on a line has been read, and also whenever EOF is true. (A "text character" here



means a character that is not the RETURN character.)

- For an INTERACTIVE file, EOF is not true until the program attempts to read past the last character in the file, or until the CTRL-C character is read from a character device. EOLN is not true until the RETURN character at the end of the line has been read or until EOF is true.



If you are using READ with a CHAR variable and you need to detect the end of an input line, you may be able to simplify the situation by using READLN with a STRING variable instead; this gives you line-oriented reading without the need to check EOLN (see below).

### READ with a STRING Variable

For a variable of type STRING, READ reads all the characters up to the end of the line or until a CTRL-C is read from a character device. The RETURN character, or CTRL-C from a character device, is not read. If this is directly followed by another READ with a string variable, the result is to read nothing, since there are no more characters on the line. This can lead to an infinite loop if not handled correctly. We therefore recommend that you use READLN with a string variable; this has the same effect as READ except that READLN skips to the beginning of the next line after reading.

### READ with a Numeric Variable

For a variable of type INTEGER, LONG INTEGER, or REAL, READ expects to read a string of characters which can be interpreted as a numeric value of the same type. Any space or RETURN characters preceding the numeric string are skipped. The string includes all characters up to the first character that does not fit the syntax for an integer or real value representation (depending on the variable), or up to the end of the file.

The string is converted to a numeric value and the value is assigned to the variable. For example,

```
READ(X)
```

(where X is a REAL variable) reads characters from the INPUT file (the keyboard). It first skips any spaces or RETURNS; then it

reads as many subsequent characters as it can interpret as part of a real number. Spaces, RETURNS, and end-of-files, will frequently delimit reals in a text file, since use of WRITE and WRITELN will produce just such files. The interpreted value is assigned to X.

If READ(X) does not find a numeric string after skipping spaces and RETURNS, the program is halted with an error message. (For further information, refer to Appendix E.)

If nothing but spaces and/or RETURNS are found before the end-of-file, the result depends on whether READ is looking for a REAL or an INTEGER value. If READ is looking for an INTEGER value, a value of 0 is read; but if READ is looking for a REAL value, the program is halted with an error message.

After the READ, the next READ or READLN will always start with the character immediately following the last character of the numeric string.

If the last character of the numeric string is the last character on the line, then EOLN will be true. If the last character of the numeric string is the last character in the file, then EOF and EOLN will both be true.

Note that the behavior of READ with a numeric variable is exactly the same regardless of whether the file is TEXT or INTERACTIVE.



The standard system library file, SYSTEM.LIBRARY, contains a library unit called PASCALIO. READ or READLN with a REAL variable cannot be executed unless this unit is available in a library at the start of execution.



When READ is looking for a REAL value:

- any number of characters can be read for a REAL variable, but at most 9 significant digits are converted.
- READ will use decimal-to-binary conversion methods that are slightly different from those used for REAL values written in the program as constants.

- READ will accept '.NaN.' (any combination of upper- and lower-case characters) as a REAL value which is "not a number".
- READ will accept a string of two or more plus signs as positive infinity and two or more minus signs as negative infinity.

See Appendix E for further information.

With the exception of NaNs and infinities, the syntax of a real number entered by READ is the same as the syntax of a real number appearing in a program.

Apart from these differences, the rules are the same as those for constants of type REAL. In particular, note that if there is a decimal point it must be preceded and followed by numeric digits.

## The READLN Procedure

This procedure may be used only on character files. It allows line-oriented reading of characters, strings, and numeric values. The syntax for calling READLN is

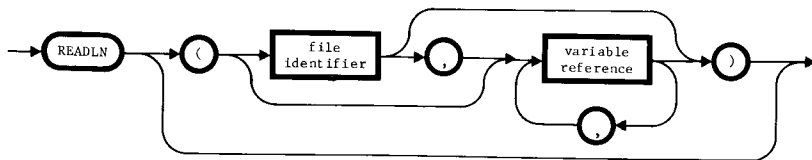

where the file identifier must refer to an open character file. If the file identifier is omitted, INPUT is assumed. Each variable may be of type CHAR, STRING, INTEGER, LONG INTEGER, or REAL.

READLN works exactly like READ, except that after a value has been read for the last variable, the remainder of the line is skipped (including the RETURN). After any READLN, the next READ or READLN will always start with the first character of the next

line, if there is a next line. If there is no next line, EOF will be true. If EOF is already true, an I/O error will occur.

READLN with a STRING variable reads all the characters up to but not including the RETURN character, then skips to the next line. Thus repeated READLNs with a STRING variable have the effect of reading successive lines of the file as strings.

Unlike READ, READLN can be called with no variable references at all. READLN with no variable references simply skips to the beginning of the next line in the input file.

One of the most common uses of READLN with a STRING variable is to read a string of characters from the keyboard. In the following example, READLN is used to read a pathname typed by the user:

```

PROGRAM MAKEFILE;

VAR F: FILE OF REAL;
    I: INTEGER;
    NAME: STRING;

BEGIN
  {Ask user for pathname.}
  WRITE('Type name of file: ');
  {Accept line typed by user.}
  READLN(NAME);
  {If pathname has no suffix, add customary .DATA suffix.}
  IF POS('.', NAME)=0 THEN NAME:=CONCAT(NAME, '.DATA');
  {Open with REWRITE since this is a new file}
  REWRITE(F, NAME);
  ...

```

Another useful example is given below under WRITE and WRITELN.

## The WRITE Procedure

This procedure may be used only on character files. It allows characters, strings, and numeric values to be written to a file as text strings, without the need for explicit use of PUT or explicit reference to the window variable. The syntax for calling WRITE is

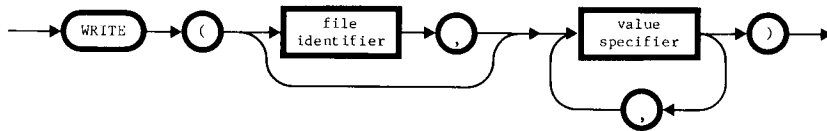

where the file identifier must refer to an open character file. If the file identifier is omitted, OUTPUT is assumed. Each "value specifier" has the following syntax:

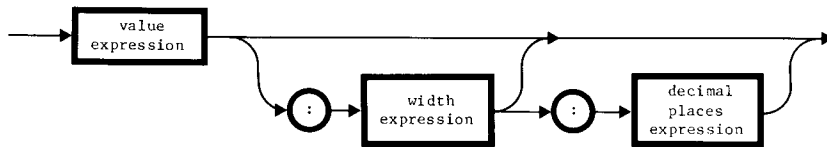

The "value expression" may have an INTEGER, REAL, STRING, CHAR, or LONG INTEGER value; these are values to be written out as text strings. Also, the identifier of a one-dimensional PACKED ARRAY OF CHAR may be used; all of the characters in the array are written out as a string.

A "width expression" must have a positive INTEGER value. If present, it specifies the minimum number of character positions to be occupied by the string that is written out. If no width is specified for a value, the default width is exactly enough character positions to hold the value. If the value written out is shorter than the width, spaces are added on the left to fill the width (i.e., the value is right-justified within the width).

When an INTEGER value is written out, the sign is written only if it is negative. If the sign is positive, a space is written instead.

When a REAL value is written out, the rules are slightly different. The value is always preceded by at least one space, regardless of the width specification. After the space, the sign is written only if it is negative. Nothing is written for a positive sign.

A "decimal places expression" is only allowed after a REAL value. It must have a positive INTEGER value. If present, it specifies the number of decimal places to be written out. The number is written in "fixed-point" form, i.e., the exponent notation is not used. If necessary, the value is rounded (not truncated) to the specified number of decimal places.

If a string value or PACKED ARRAY OF CHAR is longer than the specified width, the value or array is truncated on the right to fit the specified width.

If the "value expression" has a numeric value, the WRITE procedure always writes the entire value. The "width expression" is ignored if the numeric value is longer than the specified width, or if the width is too short to contain the specified number of decimal places.

If the number of decimal places is not specified, the value is rounded to 6 significant digits, the decimal point is placed between the first and second digits, and the exponent notation is used.

Regardless of the width and decimal places specified, no more than 9 significant digits are ever written out.



A numeric value written out by WRITE or WRITELN produces exactly the same number when read back by READ or READLN if one of the following conditions is true:

- the value is written as a 6-digit number and read as a 6-digit number; or
- the value is written as a 9-digit number and read as a 9-digit number.

Special characters are handled by the WRITE procedure as follows:

- Whenever a RETURN character (ASCII 13) is written to a character device, a linefeed (ASCII 10) is automatically written out immediately after the RETURN

character. This is not done when output is to a diskette file.

- When a DLE-blank code (ASCII 16 followed by another character) is written to a character device, the DLE-blank code is "expanded" to a sequence of spaces. The DLE-blank coding is explained in Chapter 12. DLE-blank codes are not expanded when output is to a diskette file; the DLE character and the next character are written like any other characters.
- No special handling is provided for the CTRL-C character; but note that the console treats this character as a screen-control code. In general, do not write any control character to the console unless you carefully study the "Screen Control Codes" section of the Standard Device Drivers Handbook.



Because of the special handling of control characters, WRITE is not recommended for control-character communication with a SOS device driver. To control a device driver by sending it control characters, use UNITREAD and UNITWRITE as explained in Chapter 12.



The standard system library file, SYSTEM.LIBRARY, contains a library unit called PASCALIO. WRITE or WRITELN with a REAL variable cannot be executed unless this unit is available in a library at start of execution.

## The WRITELN Procedure

WRITELN works exactly like WRITE, except that after the last value has been written a RETURN character (ASCII 13) is written to end the line. If output is to a character device, the RETURN character is automatically followed by a linefeed (ASCII 10). The syntax for calling WRITELN is

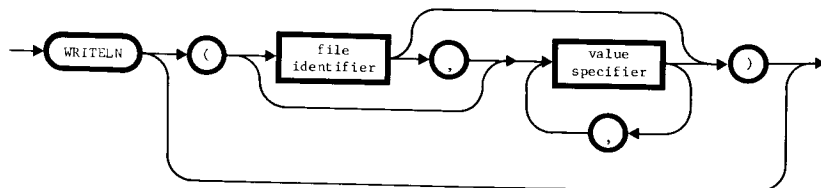

The syntax for a "value specifier" is given above under WRITE. WRITELN with no value specifiers skips to the next line in the output.

The following example uses WRITELN to produce formatted output on the screen, namely a table of the ASCII codes for the digits '0'..'9':

```

PROGRAM ASCIITABLE;

VAR DIGIT: CHAR;

BEGIN
  WRITELN('Character    Code');
  WRITELN;
  FOR DIGIT := '0' TO '9' DO
    WRITELN(DIGIT:5, ORD(DIGIT):12)
  END.
  
```

The following example program illustrates a number of useful techniques. It uses line-oriented I/O with STRING variables, and performs character manipulations on the STRING variables. It also shows the use of IORESULT to stop the program if the input file does not exist. The effect of the program is to read the input file line by line, remove any leading periods from the lines, and write the lines out to the output file.

```

PROGRAM FLUSHPERIODS;

CONST PERIOD='.';

VAR INFILE, OUTFILE: TEXT;
    INNAME, OUTNAME, LINEBUF: STRING;
  
```

```
BEGIN
```

```

{First get the files open.}
{Get input pathname.}
WRITE('Name of input file: ');
READLN(INNAME);
{Supply the default suffix .TEXT if needed.}
IF POS('.', INNAME)=0
  THEN INNAME:=CONCAT(INNAME, '.TEXT');

{Turn off automatic error checking so program can do it.}
{$IOCHECK-}
{Input file should already exist, so open with reset.}
RESET(INFILE, INNAME);
{If it doesn't work, complain and stop program.}
IF IORESULT<>0 THEN BEGIN
  Writeln('File not found. ');
  EXIT(PROGRAM)
END;
{Turn automatic error checking back on.}
{$IOCHECK+}

{Get output pathname.}
WRITE('Name of output file: ');
READLN(OUTNAME);
{Supply default suffix .TEXT if needed.}
IF POS('.', OUTNAME)=0
  THEN OUTNAME:=CONCAT(OUTNAME, '.TEXT');
{Open file with rewrite.}
REWRITE(OUTFILE, OUTNAME);

{Now do the job.}
WHILE NOT EOF(INFILE) DO BEGIN
  READLN(INFILE, LINEBUF);
  WHILE POS(PERIOD, LINEBUF)=1 DO DELETE(LINEBUF, 1, 1);
  Writeln(OUTFILE, LINEBUF)
END;

{Now clean up.}
CLOSE(OUTFILE, LOCK);
CLOSE(INFILE)
END.
```

## The PAGE Procedure

This procedure sends a form feed character (ASCII 12) to the file. The form is

```
PAGE ( FILEID )
```

where FILEID must be the identifier of an open character file. Note that PAGE(OUTPUT) has the effect of placing the cursor at the top left corner of the screen without clearing the screen.

## Additional Details

The following facts about READ and READLN are important if you combine text I/O with GET and PUT calls, or mix reading and writing operations on the same file variable. You may also need to know exactly when EOLN and EOF become true with READLN and with numeric variables.

Note that for mixed reading and writing, the rules given below are more straightforward for INTERACTIVE files than for TEXT files.

After READ with a CHAR variable and an INTERACTIVE file:

- The file buffer variable contains the character that was read, unless EOLN or EOF is true.
- If the next I/O operation is a PUT, WRITE, or Writeln, the operation begins with the character after the one that was read.
- EOF is true if the character read was beyond the end of the file or was a CTRL-C character from a character device. In this case the value of the file buffer variable is undefined.
- EOLN is true if the character read was the RETURN character. In this case the file buffer variable contains a space.

- EOLN is also true if EOF is true.

After READ with a CHAR variable and a TEXT file:

- The file buffer variable contains the character after the character that was read, unless EOLN or EOF is true.
- If the next I/O operation is a PUT, WRITE, or WRITELN, the operation begins with the second character after the one that was read.
- EOF is true if the character read was the last character in the file or if a CTRL-C was read from a character device. In this case the value of the file buffer variable is undefined.
- EOLN is true if the character read was the last character on the line (not counting the RETURN character). In this case the file buffer variable contains a space.
- EOLN is also true if EOF is true.

After READ with a numeric variable and a TEXT or INTERACTIVE file:

- The file buffer variable contains the character after the last character of the numeric string that was read, unless EOLN or EOF is true.
- If the next I/O operation is a PUT, WRITE, or WRITELN, the operation begins with the second character after the last character of the numeric string.
- EOF is true if the last character of the numeric string was the last character in the file or a CTRL-C was read from a character device. In this case the value of the file buffer variable is undefined.
- EOLN is true if the last character of the numeric string was the last character on the line (not counting the RETURN character). In this case the file buffer variable contains a space.
- EOLN is also true if EOF is true.

After READ with a STRING variable and a TEXT or INTERACTIVE file:

- The file buffer variable contains a space which represents the RETURN character at the end of the line, unless EOF is true.
- If the next I/O operation is a PUT, WRITE, or WRITELN, the operation begins with the first character on the next line.
- EOF is true if the line read was the last line in the file. In this case the value of the file buffer variable is undefined.
- EOLN is always true.

After READLN with any variable and an INTERACTIVE file:

- The file buffer variable contains a space which represents the RETURN character at the end of the line, unless EOF is true.
- If the next I/O operation is a PUT, WRITE, or WRITELN, the operation begins with the first character on the next line.
- EOF is true if the line read was the last line in the file. In this case the value of the file buffer variable is undefined.
- EOLN is never true.

After READLN with any variable and a TEXT file:

- The file buffer variable contains the first character on the next line, unless EOLN or EOF is true.
- If the next I/O operation is a PUT, WRITE, or WRITELN, the operation begins with the second character on the next line.

- 
- EOF is true if the line read was the last line in the file. In this case the value of the file buffer variable is undefined.
  - EOLN is true only when EOF is true.

**12****Block File I/O and Device I/O**

## Introduction

This chapter describes the two lower levels of I/O provided by Apple III Pascal: block file I/O, and device I/O. These methods allow higher speed and more direct control of the I/O process, by omitting most of the automatic features of the higher levels of I/O.

The last section of this chapter describes the difference between files of external types "Textfile" and "Asciifile". The difference is invisible to a Pascal program unless it uses the methods described in this chapter.

## Block File I/O

Block file I/O treats a file variable as a sequence of 512-byte "blocks"; the bytes are not type-checked but considered as raw data. This can be useful for applications where the data need not be interpreted at all during I/O operations.

The external file is still handled as described in earlier chapters; it has a pathname which is found in a directory, it must be opened and closed, etc.

To use block file I/O, the file is declared as a block file, and the BLOCKREAD and BLOCKWRITE functions are used for input and output.

### Block File Declarations

Block files are sometimes called "untyped" files, because they are declared with no component type. The type for a block file variable is simply FILE. For example, the declaration

```
VAR INFILE, OUTFILE: FILE;
```

declares two file variables, INFILE and OUTFILE. They have no component types, so they are block files.

A block file is opened and closed like any other file. The type of the external file ("Textfile," "Asciifile," "Datafile," etc.)

is totally ignored.

A block file has no buffer variable, and it cannot be used with GET, PUT, or any of the text I/O procedures. It can only be used with RESET, REWRITE, CLOSE, EOF, and the BLOCKREAD and BLOCKWRITE functions described below.

### The BLOCKREAD Function

This function is used to transfer one or more 512-byte blocks of data from a block file to a program variable. The value returned is the number of blocks actually transferred. The syntax for calling BLOCKREAD is

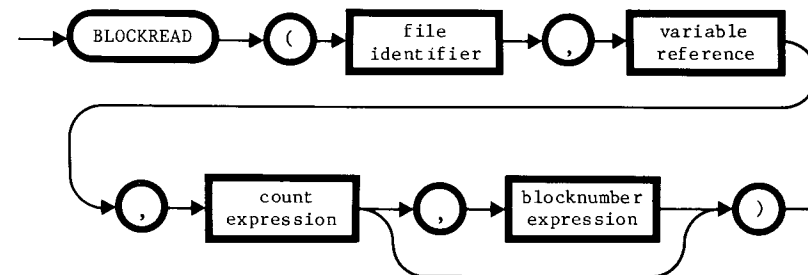

where

- The file identifier must be the identifier of an open block file.
- The variable reference refers to the variable into which the blocks of data will be read. The size and type of this variable are not checked; if it is not large enough to hold the data, other program data may be overwritten and the results are unpredictable.
- The "count expression" is an expression of integer value that specifies the number of blocks of data to be transferred. BLOCKREAD will read as many blocks as it can, up to this limit; if the end of the file is reached before the specified number of blocks are read, then EOF will be true and the value returned by



BLOCKREAD indicates how many blocks were actually read.

- The "blocknumber expression" is an expression of integer value that specifies the starting block number in the file (see below).

The blocks in a file are considered to be numbered sequentially starting with 0. The system keeps track of the "current" block number in each open block file; this is block 0 immediately after the file is opened. Each time a block is read, the current block number is incremented. If the blocknumber expression is omitted in a call to BLOCKREAD, the transfer begins with the current block. Thus the transfers are sequential if the blocknumber expression is never used; if a blocknumber expression is used, it provides random access to blocks.

After BLOCKREAD, EOF is true if the last block in the file was read.

### The BLOCKWRITE Function

This function is used to transfer one or more 512-byte blocks of data from a program variable to a block file. The value returned is the number of blocks actually transferred. The syntax for calling BLOCKWRITE is

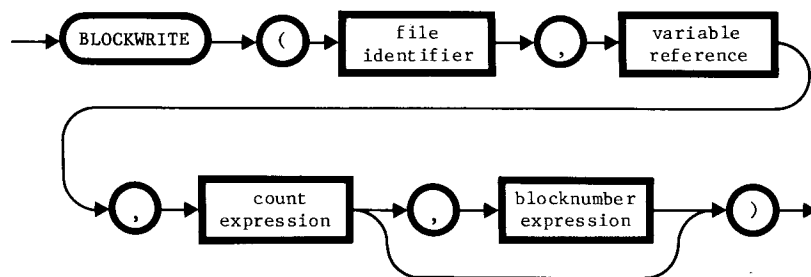

where

- The file identifier must be the identifier of an open block file.

- The variable reference refers to the variable from which the blocks of data will be read. The size and type of this variable are not checked; if it is not large enough to contain the specified number of blocks of data, other program data will be written out to the file.
- The "count expression" is an expression of integer value that specifies the number of blocks of data to be transferred. BLOCKWRITE will write as many blocks as it can, up to this limit; if the available space is used up before the specified number of blocks are written, then EOF will be true and the value returned by BLOCKWRITE indicates how many blocks were actually written.
- The "blocknumber expression" is an expression of integer value that specifies the starting block number in the file (see explanation above under BLOCKREAD).

### Using Block I/O

The following program is an example of the use of block I/O. It simply copies one diskette file to another. This could be done by transferring one block at a time, but the program can execute faster by transferring two blocks at a time, using a buffer variable whose size is 1024 bytes. Since a file might contain an odd number of blocks, the program must make sure that after each BLOCKREAD, the subsequent BLOCKWRITE transfers the same number of blocks that were read.

```

PROGRAM FILECOPY;
{Copy one diskette file to another.}

VAR INFILE, OUTFILE: FILE;

PROCEDURE OPENINPUT;
{Open the input file.}
VAR INNAME: STRING;
BEGIN
  WRITE('Type pathname of input file: ');
  READLN(INNAME);
  RESET(INFILE, INNAME)
END;
  
```

```

PROCEDURE OPENOUTPUT;
{Open the output file.}
  VAR OUTNAME:STRING;
  BEGIN
    WRITE('Type pathname of output file: ');
    READLN(OUTNAME);
    REWRITE(OUTFILE, OUTNAME)
  END;

PROCEDURE TRANSFER;
{Transfer blocks two at a time from input file, to buffer
variable, to output file, until end of input file.}

  VAR COUNT: INTEGER;
      BUF: PACKED ARRAY[1..1024] OF CHAR;
      {The important thing about BUF is that it is exactly
      1024 bytes in size--equivalent to two blocks. The
      BLOCKREAD and BLOCKWRITE functions do not check for
      this, and they do not care that it happens to be a
      packed array of char.}

  BEGIN
    WHILE NOT EOF(INFILE) DO BEGIN
      COUNT := BLOCKREAD(INFILE, BUF, 2);
      COUNT := BLOCKWRITE(OUTFILE, BUF, COUNT)
    END
  END;

BEGIN {Main program}
  OPENINPUT;
  OPENOUTPUT;
  TRANSFER;
  CLOSE(INFILE);
  {LOCK to make new file permanent.}
  CLOSE(OUTFILE, LOCK)
END.

```

## Device I/O

The Pascal system identifies each peripheral device by a unit number and a unit name. SOS device names may also be used. The numbers and names for standard devices are

SOS DEVICE NAME	PASCAL UNIT #	PASCAL UNIT NAME
.CONSOLE	1	CONSOLE:
.CONSOLE	2	SYSTEM:
.GRAFIX	3	GRAPHIC:
.D1	4	(volume name)
.D2	5	(volume name)
.PRINTER	6	PRINTER:
.RS232	7	REMIN:
.RS232	8	REMOUT:
.D3	9	(volume name)
.D4	10	(volume name)

The distinction between units 1 and 2 (CONSOLE: and SYSTEM:) is that I/O operations using SYSTEM: (unit 2) do not cause typed characters to be echoed on the screen. The built-in Pascal file identifier KEYBOARD is associated with the SYSTEM: unit, and the built-in Pascal file identifiers INPUT and OUTPUT are associated with the CONSOLE: unit.

The distinction between units 7 and 8 (REMIN: and REMOUT:) is that unit 7 is used for input and unit 8 is used for output. Both are associated with the SOS device .RS232.

Note that if there is a printer-like driver present (e.g., .SILENTYPE ) and no .PRINTER, the printer-like driver is assigned the Pascal unit name PRINTER: and its unit number is 6.

Non-standard devices are assigned sequential unit numbers in the range 128 through 255 according to their order in SOS.DRIVER. (See Standard Device Drivers Handbook.)

The procedures described below can be used for direct communication with any peripheral device.

## The UNITREAD and UNITWRITE Procedures

These are the procedures that perform device-oriented I/O. They are dangerous procedures. Unlike the other I/O procedures, these do not offer any protection against mistakes. In particular, UNITWRITE allows you to write any block on a disk without knowing what it contains; thus you can easily destroy a disk directory. Use these procedures cautiously. The syntax is

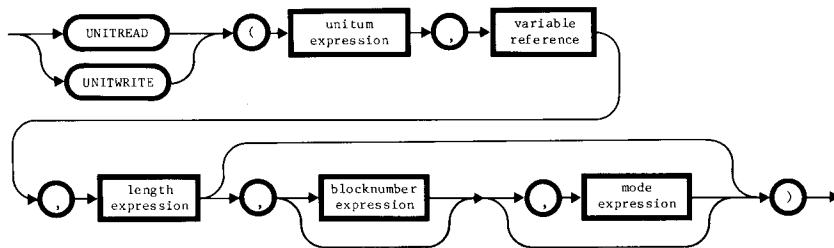

where

The "unitnum expression" is an expression with an integer value, which is the unit number of an I/O device.

The variable reference refers to a program variable, whose contents are to be transferred to or from the unit. As with the block I/O procedures (see above), the type and size of this variable are not checked; if the size of the variable does not match the specified number of bytes to be transferred, results are unpredictable.

The "length expression" is an expression with an integer value, which specifies the number of bytes to transfer.

The "blocknum expression" is an expression with an integer value. It is meaningful only when using a disk drive and is the absolute block number at which the transfer will start. If the blocknum expression is omitted and the unit is a disk drive, the transfer will start at block 0.

The "mode expression" is an expression with an integer value; if it is omitted, the default is 0. It controls options which are described below.

For UNITWRITE, the options controlled by the "mode" parameter apply only to character devices; they do not apply to block-structured devices. Both options are enabled by default, if no "mode" parameter is supplied. They are designed to handle the special coding found in "Textfiles", and are convenient when text is read from such a file with UNITREAD and then output via UNITWRITE to a character device.

One option is conversion of DLE-blank codes. These are found in "Textfiles", as explained in the last section of this chapter. On output to a character device, this option detects the DLE-blank code and converts it into a sequence of spaces.

Conversion of DLE-blank codes is disabled by a "mode" value that has a one in Bit 2 (see below).

The other option is automatic linefeeds. In character files, the end of each line is marked by a RETURN character (ASCII 13) without any linefeed character. On output to a character device, the automatic linefeed option inserts an LF character (ASCII 10) after every RETURN.

Automatic linefeeds are disabled by a "mode" value that has a one in Bit 3 (see below).

For UNITREAD, the only option is CTRL-C recognition (enabled by default). When the CTRL-C character (ASCII 3) is recognized by UNITREAD, the effect is to terminate the input. Any bytes in the destination variable that remain unused at this point are filled with 0's.



When unit 1 (CONSOLE:) is read with UNITREAD, characters typed on the keyboard are echoed (as with other methods of input). The echoing is performed by UNITWRITE, using the same mode parameter supplied to UNITREAD. Usually this has no noticeable effect, but it might cause a surprising result with certain modes and certain input characters.

Only Bit 2 and Bit 3 of the "mode" value have any significance. Bits 0, 1, and 4..12 are reserved for future use; bits 13..15 are unassigned.

Bit 2, by itself, corresponds to a value of 4, and Bit 3 by itself corresponds to a value of 8. The following values can be used to control the options:

- Mode =  $\emptyset$  (the default value) enables all options.
- Mode = 4 disables DLE conversion and CTRL-C recognition, and enables automatic linefeeds.
- Mode = 8 disables automatic linefeeds and enables DLE conversion and CTRL-C recognition.
- Mode = 12 disables all options. This mode should be used for control-character communication with SOS driver programs.



Note that UNITREAD and UNITWRITE are not controlled in any way by the format in which files are stored on a diskette; they treat an entire diskette as one sequence of blocks. Therefore, files on Apple II formatted diskettes and files on SOS-formatted diskettes will not be accessed in the same way by these built-ins. Don't use these procedures with diskette files unless you know exactly what you're doing.

### The UNITCLEAR Procedure

This procedure cancels all I/O operations to the specified unit and resets the hardware to its power-up state. The form is

```
UNITCLEAR ( UNITNUM )
```

where UNITNUM is an expression with an integer value, which is the unit number of an I/O device.

IORESULT is set to a non-zero value if the specified unit is not present (you can use this to test whether or not a given unit is present in the system). Note that UNITCLEAR (1) flushes the type-ahead buffer for the console and resets certain keyboard and screen parameters.



For any device except the console, UNITCLEAR is equivalent to the SOS device control call with the control parameter set to zero to indicate a RESET operation.

### The UNITSTATUS Procedure

This procedure communicates with the SOS device driver program associated with a specified unit. It can either check the current status parameters for the device's input or output channel, or perform a control operation on the device.

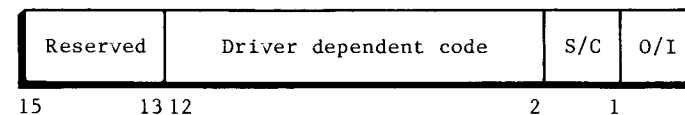

UNITSTATUS: OPTION Format

The form is

```
UNITSTATUS ( UNITNUM, DATA, OPTION )
```

where

UNITNUM is an expression with an integer value that is the unit number of an I/O device.

DATA is a variable reference. The variable is assumed to contain either control information to be transferred to the device driver, or status information to be retrieved from it. For most devices, this variable should be an ARRAY[ $\emptyset$ ..29] OF INTEGER, but this may differ for certain devices. The type and size of this variable are not checked.

OPTION is an expression with an integer value whose individual bits control the operation of the UNITSTATUS procedure as follows:

Bit  $\emptyset$ : If this bit is  $\emptyset$ , the output channel of the unit is specified; if it is 1, the input channel is specified. For most devices, there is no distinction between input and output channels and this bit is ignored; it is also ignored if the device has

only one channel (e.g., a printer).

Bit 1: If this bit is 0, UNITSTATUS will put the current status parameters of the device driver into the specified program variable (calling the SOS device status procedure). If it is 1, UNITSTATUS will use the values in the program variable to update the status parameters of the device driver (using the SOS device control procedure).

Bits 2..12: These bits are sent to the device driver, which uses them to select a particular status or control operation. For further information on these status codes and control codes, see the Standard Device Drivers Handbook.

Bits 13..15: These bits are reserved for future use. They should be set to zero.

As an example of the use of UNITSTATUS, consider the problem of determining whether a character is present in the keyboard typeahead buffer. The console driver will return the number of characters in the typeahead buffer in response to a device status call with a parameter of 5. UNITSTATUS, with the following parameters, will issue this device status call:

```
UNITNUM = 1 to specify the console unit.
```

A reference to an INTEGER variable to contain the result returned from the console driver. (Note that in this case we do not use an ARRAY[0..29] OF INTEGER; the type of variable used here depends on the device.)

```
OPTION = 21, which has the following bit values:
```

Bit 0 = 1 to specify the input channel of the console.

Bit 1 = 0 to specify a device status call (retrieve status information from device driver).

Bits 2..12 cause the console driver to return the number of characters in the typeahead

buffer. Bits 2 and 4 are set to 1; all others in the range are set to zero.

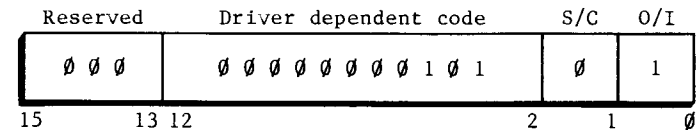

UNITSTATUS: OPTION = 21

The following function uses this UNITSTATUS call. It returns true if the typeahead buffer contains one or more characters; thus it can be used to find out whether any character has been typed since the last time the keyboard was read or cleared.

```
FUNCTION KEYPRESS: BOOLEAN;
VAR CHARCOUNT: INTEGER;
BEGIN
  CHARCOUNT:= 0;
  UNITSTATUS(1, CHARCOUNT, 21);
  KEYPRESS := CHARCOUNT <> 0;
END;
```

Note that this KEYPRESS function is provided in the APPLESTUFF library unit (see Appendix D).

## Textfiles and Asciifiles

When a diskette file is created, it is assigned one of the external file types described in the Introduction, Filer, and Editor manual. Character files are generally of external type "Asciifile" or "Textfile"; but note that for purposes of Pascal program I/O, the other external types ("Datafile" in particular) are equivalent to "Asciifile".

When you create a file via the Filer or via a user Pascal program, the type depends on the suffix used as the last part of the pathname. Files created with the suffix .ASCII are of type

"Asciifile". Files created with the suffix .TEXT are of type "Textfile".

The Editor creates "Textfiles" by default, and can create "Asciifiles" on request. The Editor reads files as "Textfiles" unless they are of external type "Asciifile", in which case it assumes no special formatting.

### Textfile Structure

"Textfiles" have a special physical format that includes other data besides the characters that appear to a Pascal program. When you access a "Textfile" with the I/O procedures of Chapters 10 and 11, all of this extra data is invisible; but when you use block I/O or device I/O, the extra data and the special formatting are visible.

The special format of a "Textfile" is as follows:

- There are two blocks (1024 bytes) of "header" information at the beginning of the file. When RESET opens a "Textfile" (using a file variable of type TEXT or INTERACTIVE), these 1024 bytes are skipped. When REWRITE opens a "Textfile" (using a variable of type TEXT or INTERACTIVE), these 1024 bytes are automatically written out with default values. In other words, the header blocks are normally invisible to a Pascal program. However, if the file variable is not a character file, the header information is treated as ordinary data.
- The rest of the file consists of two-block "pages." Each page contains lines of text, separated from each other by RETURN characters (ASCII 13). No line ever crosses a page boundary; thus a page contains only whole lines. After the last line on a page, the remainder of the page is filled with NUL characters (ASCII 00). READ and READLN skip the NUL characters, and WRITE and WRITELN provide them automatically. Thus this "page" formatting is also normally invisible to a Pascal program. However, if the file variable is not a character file, the NUL characters are treated as ordinary data.
- A sequence of leading spaces in a line may be compressed to a "DLE-blank code." This is a DLE

control character (ASCII 16) followed by one byte containing the number of spaces to indent plus 32 (decimal). This saves a considerable amount of space in files where indentation is used heavily. The Editor is the main creator of DLE-blank codes; it usually outputs a DLE-blank code where a sequence of spaces occurs at the beginning of a line. Of course, Pascal user programs may also use this coding in creating "Textfiles".

GET, READ, and READLN convert DLE-blank coding to actual spaces on input from a "Textfile" to a file variable of type TEXT or INTERACTIVE; thus the compression of spaces is also normally invisible to a Pascal program.

Note that it is still possible for a "Textfile" to contain actual sequences of spaces, including leading spaces on a line, depending on how the data was actually created and output. Also, a line with no indentation may or may not be preceded by a DLE character and an indent code value of 32 (meaning 0 indentation).

Various parts of the system that deal with files of characters (such as the Editor and the Compiler) are designed to take advantage of the special "Textfile" format. For most purposes, it is recommended that you use the "Textfile" type for any character files created by your programs.

### Asciifile Structure

Text files created by BASIC are "Asciifiles"; since the Pascal Editor can handle these files, it can be used to edit BASIC text files. (See the Introduction, Filer, and Editor manual.) Likewise, Pascal programs can be written to process such files.

The "Asciifile" type can also be used for files created by Pascal programs, in certain situations--for example, where character-level random access is required.

Note that for purposes of Pascal program I/O, there is actually no distinction between "Asciifiles" and other diskette files that are not "Textfiles".

---

An "Asciifile" contains a sequence of characters; for purposes of a Pascal program, each character that is in the external file appears as one record of a file variable of type TEXT or INTERACTIVE.

Physically, the file is a sequence of 512-byte blocks (not 2-block pages). There are no header blocks; the first character in the file is the first byte in the first block.

Lines in an "Asciifile" may cross block boundaries; there is no filling with NUL characters, except in the last block where any unused bytes after the last file character are filled with NULs.

On output to an "Asciifile" from the Editor, sequences of spaces are not converted to DLE-blank codes. If an "Asciifile" does contain a DLE-blank code, it is not interpreted or converted on input to a Pascal program; it simply appears as two characters, namely the DLE character followed by some character whose ASCII code is the indent code. Thus all spaces in an "Asciifile" should be represented by actual space characters.

**13****Special-Purpose Built-Ins**

## Introduction

This chapter describes two sets of built-in features of Apple III Pascal: the byte-oriented features and three "miscellaneous" procedures.

## Byte-Oriented Features

These features allow a program to treat a program variable as a sequence of bytes, without regard to data types. The `SIZEOF` function can be used to determine the number of bytes in a variable; this is important since none of the other features described here do any checking on variable sizes.



These features make it very easy to overwrite memory areas unintentionally; use them with caution.

Typically, the byte-oriented features are used to access packed character arrays or other packed variables whose elements are stored as byte values. However, they are not restricted to such uses.

### The `SIZEOF` Function

This function returns an integer value, which is the number of bytes occupied by a specified variable, or by any variable of a specified type. `SIZEOF` is particularly useful in connection with the `FILLCHAR`, `MOVERIGHT`, and `MOVELEFT` built-ins (see below). The form is

```
SIZEOF ( IDENTIFIER )
```

where `IDENTIFIER` is either a type identifier or a variable identifier. It must not be `BYTESTREAM`, `WORDSTREAM`, a file type, or the identifier of a variable of any of these types, because these types do not have a definite size. (The `BYTESTREAM` and `WORDSTREAM` types are described further on in this chapter.)

For example, if `AREA` is declared as

```
AREA: PACKED ARRAY[0..511] OF 0..255;
```

(a packed array of 512 byte-size integer values), then the function reference

```
SIZEOF(AREA)
```

will return the value 512.

### The `FILLCHAR` Procedure

This procedure fills a specified range of memory bytes with the ASCII code of a specified character. The form is

```
FILLCHAR ( DEST, COUNT, CHARACTER )
```

where

`DEST` is a variable reference and may refer to a variable of any type except a file type. The first byte of this variable is the beginning of the range of bytes to be filled.

`COUNT` is an expression with an integer value which specifies the number of bytes to be filled.

`CHARACTER` is an expression of any scalar type whose ordinal value MOD 256 is copied into each byte in the specified range.

For example, if `AREA` is declared as in the previous example, then each of the 512 bytes of `AREA` can be filled with the numerical value 65 (the ASCII code for 'A') by either of the following statements:

```
FILLCHAR(AREA, SIZEOF(AREA), 'A')
```

or

```
FILLCHAR(AREA, SIZEOF(AREA), CHR(65))
```



## The SCAN Function

This function scans a range of memory bytes, looking for a one-character target. The target can be a specified character, or it can be any character that does not match the specified character. SCAN returns an integer value, which is the number of bytes scanned. The form is one of

```
SCAN ( LIMIT, =CHARACTER, SOURCE )   or
SCAN ( LIMIT, <>CHARACTER, SOURCE )
```

where

LIMIT is an expression with an integer value which gives the maximum number of bytes to scan. If the limit is negative, SCAN will scan backward. If SCAN fails to find the specified target, it will return the value of the limit expression.

CHARACTER is an expression with a CHAR value. If it is preceded by the = symbol, then SCAN searches for the specified character. If it is preceded by the <> symbol, then SCAN searches for any character that is not the specified character.

SOURCE is a variable reference that may refer to a variable of any type except a file type. The first byte of the variable is the starting point of the scan.

SCAN terminates when it finds the target or when it has scanned the number of bytes specified by LIMIT. It then returns the number of bytes scanned. If the target is found at the starting point, the value returned will be zero. If LIMIT is negative, the scan will go backward and the value returned will be negative or zero.

Examples: Suppose that DEM is declared as follows:

```
VAR DEM: PACKED ARRAY [0..100] OF CHAR;
```

and then the first 50 elements of DEM are loaded with the characters

```
.....THE NEXT FIVE NOTES OF THE SCALE IN SEQUENCE.
```

We then have the following:

```
SCAN(-26,=' ',DEM[30])   will return -26
SCAN(100,<>' ',DEM)      will return 5
SCAN(15,=' ',DEM[5])    will return 3.
```

## The MOVELEFT and MOVERIGHT Procedures

These procedures do mass moves of a specified number of bytes. The forms are

```
MOVELEFT ( SOURCE, DEST, COUNT )
MOVERIGHT ( SOURCE, DEST, COUNT )
```

where

SOURCE is a variable reference that may refer to a variable of any type except a file type. The first byte of this variable (lowest address) is the beginning of the range of bytes whose values are copied.

DEST is a variable reference that may refer to a variable of any type except a file type. The first byte of this variable (lowest address) is the beginning of the range of bytes that the values are copied into.

COUNT is an expression with an integer value, which specifies the number of bytes to be moved.

MOVELEFT starts from the "left" end of the source range (lowest address). It proceeds to the "right" (higher addresses), copying bytes into the destination range, starting at the lowest address of the destination range.

MOVERIGHT starts from the "right" end of the source range (highest address). It proceeds to the "left" (lower addresses), copying bytes into the destination range, starting at the highest address of the destination range.



The reason for having both of these is that the source and destination ranges may overlap. If they overlap, the order in which bytes are moved is critical: each byte must be moved before it gets overwritten by another byte.

In particular this consideration applies when source and destination are subarrays of the same array. If bytes are being moved to the right (destination has a higher subscript than source), use `MOVERIGHT`. If bytes are being moved to the left (destination has a lower subscript than source), use `MOVELEFT`.

### The *BYTESTREAM* and *WORDSTREAM* Types

These special data types allow a procedure or function to accept an array of indefinite length as a VAR parameter. Within the procedure or function, the array can be indexed with any non-negative INTEGER value. *BYTESTREAM* is used for a PACKED ARRAY OF CHAR or STRING, and *WORDSTREAM* is used for an array of scalar type.

*BYTESTREAM* and *WORDSTREAM* act within a procedure as if they were declared as follows:

```
TYPE BYTESTREAM = PACKED ARRAY[0..?] OF CHAR;
WORDSTREAM = ARRAY[0..?] OF INTEGER;
```

where the "?" means that the upper bound of the index type is not defined. *BYTESTREAM* is compatible with any PACKED ARRAY of byte-sized quantities such as CHAR, or any STRING type. *WORDSTREAM* is compatible with any non-packed array of scalars. The actual parameter may be indexed.

*BYTESTREAM* and *WORDSTREAM* can occur only in the parameter list of a procedure or function declaration.

For example, suppose that your program contains the declarations

```
VAR A : ARRAY[0..20] OF INTEGER; {21 ELEMENTS}
    B : ARRAY[1..512] OF INTEGER; {512 ELEMENTS}
```

Now suppose that you want to write a procedure that will accept, as a VAR parameter, any array of INTEGER. The procedure also accepts the number of elements in the array and an INTEGER value;

it fills all elements of the array with the INTEGER value.

```
PROCEDURE FILL (VAR INTARRAY:WORDSTREAM; COUNT,N: INTEGER);
VAR I: INTEGER;
BEGIN
  FOR I:=0 TO COUNT-1 DO INTARRAY[I]:=N
END;
```

Now to fill array A with the value 5 and array B with the value 0, write

```
FILL(A, 21, 5);
FILL(B, 512, 0)
```

Similarly, the following example shows how the type *BYTESTREAM* can be used in a procedure that accepts any PACKED ARRAY OF CHAR as a VAR parameter. The procedure goes through this array and replaces each lower-case letter that it finds with the corresponding upper-case letter. As in the previous example, the number of elements in the array must also be supplied as a parameter.

```
PROCEDURE UPPERCASE (VAR CHARRAY:BYTESTREAM; COUNT:INTEGER);
VAR OFFSET, I: INTEGER;
BEGIN
  OFFSET:=ORD('a') - ORD('A');
  FOR I:=0 TO COUNT-1 DO
    IF CHARRAY[I] IN ['a'..'z'] THEN
      CHARRAY[I]:=CHR(ORD(CHARRAY[I]) - OFFSET)
END;
```



Within a procedure or function the type must be treated as a PACKED ARRAY OF CHAR (for type *BYTESTREAM*) or an ARRAY OF INTEGER (for type *WORDSTREAM*). Range checking is never done on a parameter of type *BYTESTREAM* or *WORDSTREAM*.

Also note that within a procedure that has a *BYTESTREAM* parameter, you cannot use the *BYTESTREAM* as a parameter to `WRITE` or `WRITELN`. However you can use an indexed element of the *BYTESTREAM* as a parameter to `WRITE` or `WRITELN`, since each element of a *BYTESTREAM* is just a CHAR variable.

## Miscellaneous Procedures

### The PWROFTEN Function

This fast machine-code function returns a real value which is  $10^p$  to a specified (integer) power. The form is

```
PWROFTEN ( EXPONENT )
```

where EXPONENT is an expression with an integer value in the range 0..37. PWROFTEN returns the value of  $10^p$  to the EXPONENT power.

### The GOTOXY Procedure

This procedure sends the cursor to a specified position on the screen. The form is

```
GOTOXY ( XCOORD, YCOORD )
```

where XCOORD and the YCOORD are expressions with integer values interpreted as X (horizontal) and Y (vertical) coordinates. XCOORD must be in the range 0 through 79; YCOORD must be in the range 0 through 23. The cursor is sent to these coordinates. The upper left corner of the screen is assumed to be (0,0).

### The TIME Procedure

The form for calling TIME is

```
TIME ( HITIME, LOTIME )
```

where HITIME and LOTIME are references to integer variables; TIME sets these variables to zero. This function is available only for compatibility with Apple II.



To access the Apple III system's internal date and time, use procedures in the APPLESTUFF library unit. (See Appendix D.)

### The TREESEARCH Function

This is a fast function for searching a binary tree that has a particular kind of structure. The form is

```
TREESEARCH ( ROOTPTR, NODEPTR, NAMEID )
```

where

ROOTPTR is a pointer to the root node of the tree to be searched.

NODEPTR is a reference to a pointer variable to be updated by TREESEARCH.

NAMEID is the identifier of a PACKED ARRAY[1..8] OF CHAR which contains the 8-character name to be searched for in the tree.

The nodes of the binary tree are assumed to be linked records of the type

```
NODE=RECORD
  NAME: PACKED ARRAY[1..8] OF CHAR;
  LEFTLINK, RIGHTLINK: ^NODE;
  ...{other fields can be anything}...
END;
```

The actual identifier of the type and the field identifiers are not important; TREESEARCH assumes only that the first eight bytes of the record contain an 8-character name and are followed by two pointers to other nodes.

It is also assumed that names are not duplicated within the tree and are assigned to nodes according to an alphabetical rule: for a given node, the name of the left subnode is alphabetically less than the name of the node, and the name of the right subnode is alphabetically greater than the name of the node. Finally, any links that do not point to other nodes should be NIL.

TREESEARCH can return any of three values:

Ø: The name passed to TREESEARCH (as the third parameter) has been found in the tree. The node pointer (second parameter) now points to the node with the specified name.

1: The name is not in the tree. If it is added to the tree, it should be the right subnode of the node pointed to by the node pointer.

-1: The name is not in the tree. If it is added to the tree, it should be the left subnode of the node pointed to by the node pointer.

The TREESEARCH function does not perform any type checking on the parameters passed to it.

### The IDSEARCH Procedure

IDSEARCH is a very fast machine-language routine that scans Apple III Pascal source language for identifiers and identifies the reserved words. The Compiler uses IDSEARCH, and it is also available to programmers whose programs read Pascal source language. Note that the procedure scans only identifiers—you will have to scan special characters and comments yourself. The syntax is

```
IDSEARCH (OFFSET, BUFFER)
```

To use IDSEARCH, you must include the following declarations in your program. Note that the variables (except for BUFFER) must be declared in exactly the order and types shown.

```
TYPE
  {SYMBOL is the enumerated type of symbols in the Pascal
  language, the lines in comments are the identifiers
  corresponding to the symbols }

SYMBOL =
  {
    (ident,comma,colon,semicolon,lparent,rparent,dosy,tosy,
    {DOWNTO END UNTIL OF THEN ELSE
    downtosy,endsy,untilsy,ofsy,thensy,elsesy,becomes,
    {
      BEGIN IF CASE
    }
    lbrack,rbrack,arrow,period,beginsy,ifsy,casesy,
    {REPEAT WHILE FOR WITH GOTO LABEL CONST
    }
    repeatsy,whilesy,forsy,withsy,gotosy,labelsy,constsy,
    {TYPE VAR PROCEDURE FUNCTION ** FORWARD
    }
    typesy,varsy,procsy, funcsy, progsy,forwardsy,
    {
      NOT *** OR
    }
    intconst,realconst,stringconst,notsy,mulop,addop,
    {IN SET PACKED ARRAY RECORD FILE
    }
    relop,setsy,packedsy,arrayesy,recordsy,fileesy,otheresy,
    {
      USE UNIT INTERFACE IMPLEMENTATION
    }
    longconst,usessy,unitsy,intersy, impleesy,
    {EXTERNAL OTHERWISE
    }
    externlsy,otherwsy);

  {**: progsy is returned on both PROGRAM and SEGMENT}
  {***: mulop is returned on AND, DIV, MOD
  }

  {OPERATOR expands the multiplicative, additive and
  relational operators (mulop, addop and relop)}

OPERATOR = {
  AND DIV MOD OR
  (MUL,RDIV,ANDOP, IDIV,IMOD,PLUS,MINUS,OROP,LTOP,
  {
    IN
  }
  LEOP,GEOP,GTOP,NEOP,EQOP,INOP,NOOP);

ALPHA = PACKED ARRAY [1..8] OF CHAR;
```

```

VAR
{the next four variable must be declared in order shown}
OFFSET: INTEGER;
SY: SYMBOL;
OP: OPERATOR;
ID: ALPHA;

BUFFER: PACKED ARRAY [0..1023] OF CHAR;

...
  IF BUFFER[OFFSET] in ['A'..'Z','a'..'z'] THEN BEGIN
    IDSEARCH(OFFSET, BUFFER);
  END;
...

```

IDSEARCH begins looking for an identifier at the character pointed to by BUFFER[OFFSET] and assumes that this character is alphabetic. IDSEARCH produces the following results:

- BUFFER[OFFSET] points to the character following the identifier just found.
- ID contains the first 8 alphanumeric characters of the identifier just found, left-justified and padded with spaces as necessary.
- SY contains the symbol associated with the identifier just found if the identifier is a reserved word, or IDENT if the identifier is not a reserved word. E.g., the identifier 'MOD' translates to MULOP; the identifier 'ARRAY' translates to ARRAYSY; and the identifier 'MYLABEL' translates to IDENT.
- OP contains the operator value which corresponds to the identifier just found if the identifier is an operator, or NOOP if the identifier is not an operator. E.g., the identifier 'MOD' translates to IMOD; the identifier 'ARRAY' translates to NOOP; and the identifier 'MYLABEL' translates to NOOP.

An example of a procedure which uses IDSEARCH follows:

```

BEGIN
...
  IF BUFFER[OFFSET] in ['A'..'Z','a'..'z'] THEN BEGIN
    IDSEARCH(OFFSET, BUFFER);
  END;
...
END.

```

An algorithmic representation of IDSEARCH follows:

```
PROCEDURE IDSEARCH ( VAR OFFSET:INTEGER; VAR BUFFER: BYTESTREAM);
```

```
{ScanIdentifier increments OFFSET until BUFFER[OFFSET] is
no longer part of an identifier, copying the first 8
alphanumeric characters passed into ID (right justified,
padding with spaces)}
```

```
LookUpReservedWord translates an identifier into the
associated symbol (defaulting to IDENT)
```

```
LookUpOperator translates an identifier into the
associated operator (defaulting to NOOP)
```

```
}
```

```

BEGIN
  ID := ScanIdentifier(OFFSET, BUFFER);
  SY := LookUpReservedWord(ID);
  OP := LookUpOperator(ID);
END;

```

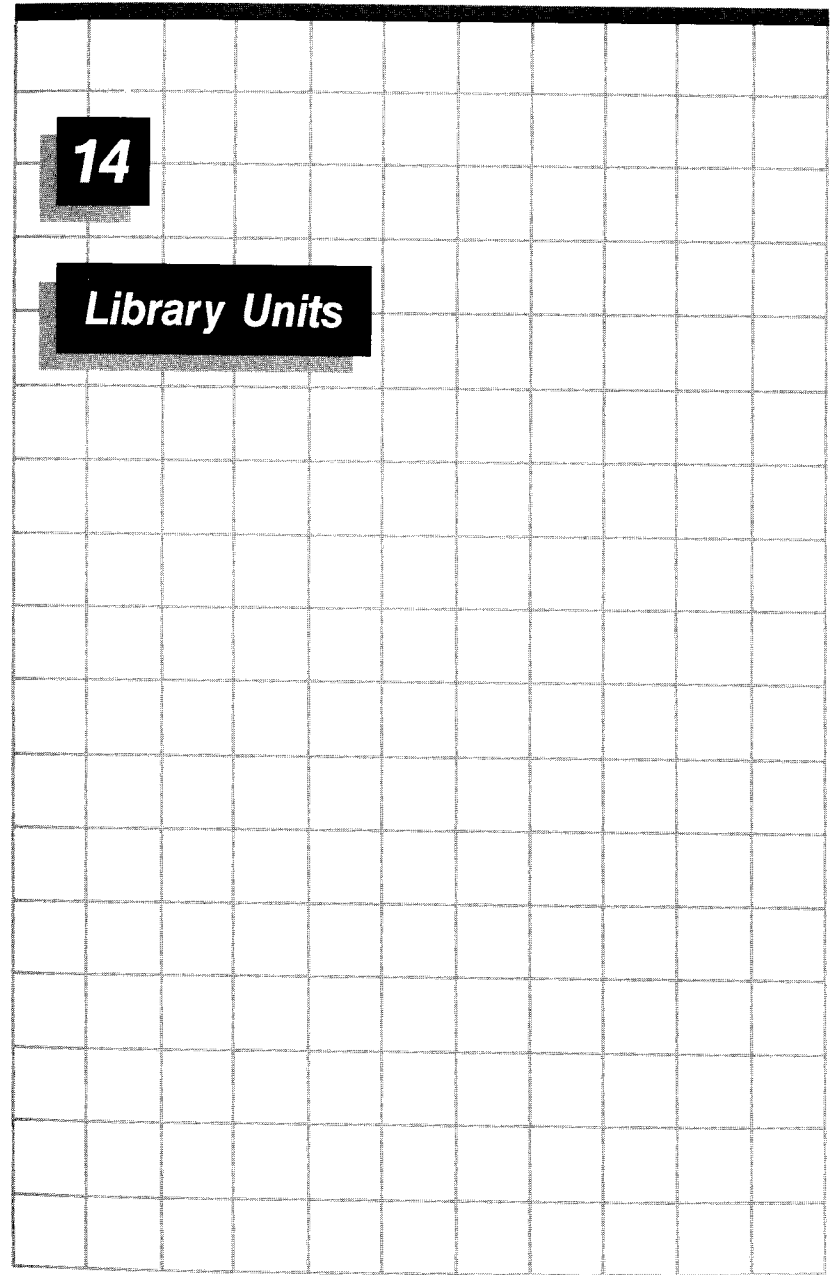

**14**

***Library Units***

## Introduction

---

So far we have seen Pascal programs, which are compiled into codefiles that can be executed directly via the RUN and XECUTE commands. Now we will consider units, which are compiled into libraries.

Units are collections of procedures that are separately compiled and then invoked as modular components of a host program. A compiled unit contains code for "public" procedures, functions, types, constants, and variables. These are available to any host program that uses the unit, just as if they were defined in the host program itself.

Units provide many advantages to the Pascal programmer.

- Units allow programs to be partitioned into logical chunks.
- Units allow programs to be written in small, separately compilable sections which are faster to compile than a single large program and which require less memory at compile time.
- Individual units can be modified without recompiling the main (host) program.
- Units contain groups of common procedures and functions that can be used in more than one program. For instance, the APPLESTUFF unit is available to all Pascal programs.
- Units are a more flexible form of program segmentation than SEGMENT procedures because you can have more than one procedure in a unit.
- Units give the Pascal programmer controlled access to "private" data structures.

Units reside in libraries. A library is a special kind of codefile that is not directly executed; instead, a compiled unit contained in a library can be used by one or more programs. To use a unit, a program must contain a USES declaration with the

name of the unit; the program is then called a host program.

Two or more libraries can be combined into one, and units can be moved from one library to another, by means of the LIBRARY utility program described in the Program Preparation Tools manual. Thus one library file can contain a number of different compiled units.

For example, the Pascal system comes with a library called SYSTEM.LIBRARY which contains code for several units (see Appendices A through E); one of the units is called APPLESTUFF, and it provides a set of procedures and functions for using special features of the Apple III. To use these procedures and functions, a program need only have the declaration

```
USES APPLESTUFF;
```

after the program heading. The program can then call APPLESTUFF procedures such as SOUND and JOYSTICK.

This chapter also explains how to create and compile your own units. The output from compiling a unit is a codefile that can be used as a library; two or more of these files can be combined into a single library by means of the LIBRARY utility.

## Regular Units

---

There are two kinds of units called "regular" and "intrinsic." When a host program uses a regular unit, the unit's code is inserted into the host program's codefile by the Linker. This need only be done once unless the unit is modified and recompiled; then it must be relinked into the host program. The diagram at the end of this section illustrates how regular units are created and used.

By default, regular units are assumed to be in the SYSTEM.LIBRARY file on the system diskette; however, you can use a regular unit that is in another library. In this case, you must use the USING option of the compiler to tell the compiler which library file contains the unit. See Appendix F.

If a regular unit used by your program is contained in the SYSTEM.LIBRARY file, a Run command will automatically invoke the Linker to do the necessary linking. Otherwise, you must use the

Compile command to compile the program and then the Link command to explicitly invoke the Linker.

#### regular units diagram

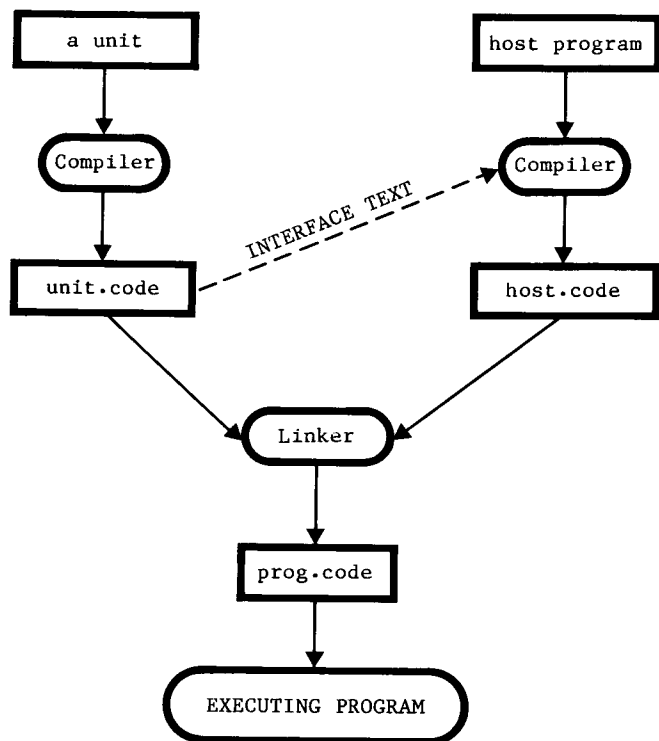

## **Intrinsic Units**

When a host program uses an intrinsic unit, the unit's code remains in its library file and is automatically loaded into memory when the host program is executed. The Linker is not needed; an intrinsic unit is "prelinked." The diagram at the end

of this section illustrates how intrinsic units are created and used.

Intrinsic units help to reduce the size of the host program's codefile. Also, an intrinsic unit can be modified and recompiled without the need to relink.

Note that an intrinsic unit must be either in the program library (see below) or in the SYSTEM.LIBRARY file on the system diskette. The library that contains the unit must be on line both when the program is compiled and when the program is executed.



The Compiler's NOLOAD and RESIDENT options (see Chapter 15 and Appendix F) allow further control over the handling of intrinsic units.

#### intrinsic units diagram

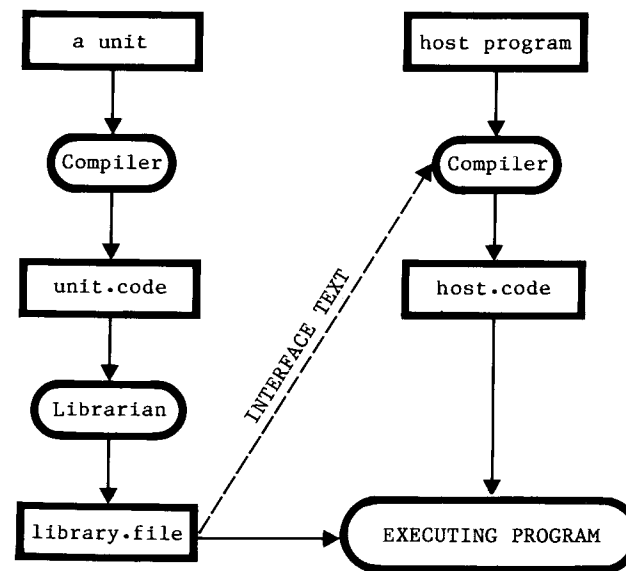



## Writing a Unit

One or more units can be written in a single file and compiled together; the syntax for a "compilation" (i.e., something that can be compiled) is

### compilation

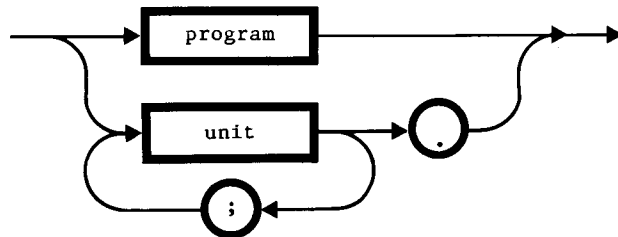

Note that a period is required at the end of every compilation (since a program ends with a period).

The source text for a unit has a form somewhat similar to a Pascal program. The overall syntax of a unit is

### unit

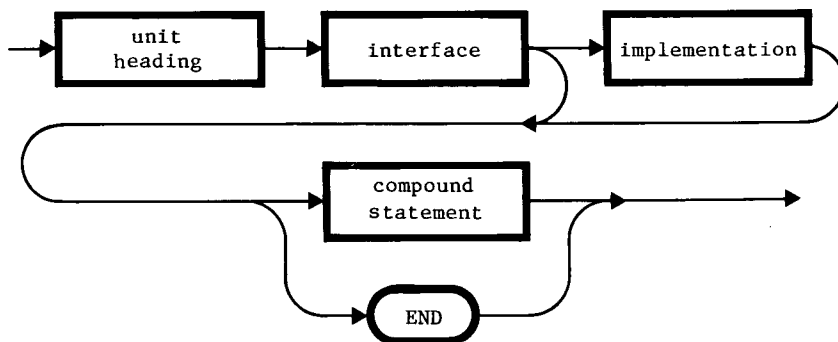

The syntax for a unit heading depends on whether the unit is regular or intrinsic, as explained in the Interface section of this chapter.

The INTERFACE declares the parts of the unit that are "public"--that is, the types, constants, variables, procedures, and functions that can be referenced by a host program. For procedures and functions, only the headings are given in the INTERFACE. The syntax is shown below.

The IMPLEMENTATION is omitted if the INTERFACE does not declare any public procedures or functions. If present, the IMPLEMENTATION declares the parts of the unit that are "private"--that is, the labels, constants, variables, procedures, and functions that are used within the unit but cannot be referenced by a host program. Also, the public procedures and functions whose headings appear in the INTERFACE are redeclared here with their bodies included. The syntax is shown below.

If a compound statement appears at the end, it is called an "initialization." This is the "main program" of the unit, and is automatically executed at the beginning of the host program. If the initialization is omitted, the unit is terminated with a single END.

Like a program, a unit is terminated with a period.

## Writing Regular Units

The heading of a regular unit has the syntax

### regular unit heading

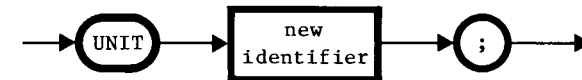

where the identifier is the identifier of the unit to be referenced in the USES declaration of a host program.

The compiled unit is linked into the host program just once after the program is compiled, and the entire unit's code is actually inserted in the host program's codefile at that time.

## Writing Intrinsic Units

The heading of an intrinsic unit has the syntax

### intrinsic unit heading

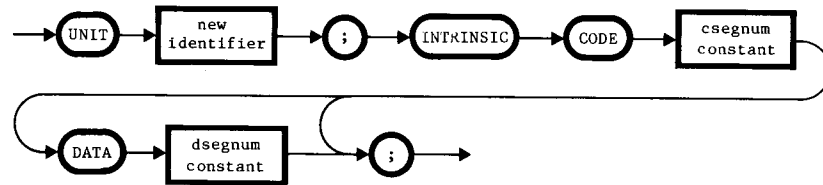

where the csegnum and dsegnum constants are the segment numbers to be used by the unit at run time. By definition, segment numbers range from 0 to 63, but certain of these numbers are reserved for the system (see below).

The unit will have a data segment if it declares any variables not contained in procedures or functions in either the INTERFACE or IMPLEMENTATION. In this case the word DATA and a data segment number are required; otherwise they must be omitted.

The code segment will have segment number csegnum and the data segment (if there is one) will have segment number dsegnum.

Every unit in a library has a specific segment number associated with it. The segment numbers used by items already in the library are shown in parentheses by the LIBRARY and LIBMAP utility programs (see Program Preparation Tools manual). In choosing segment numbers for an intrinsic unit, there are two constraints:

- No two units in the same library should have the same segment number. If they do, the system may use the wrong unit.
- When the host program runs, the various segment numbers used by the program and the system must not conflict.

Observe the following:

- While any program is executing, the main program body uses segment 1. Therefore, never use this segment number for an intrinsic unit.
- Segments 0, 2 through 6, and 59 through 63 are reserved for use by the system.
- The standard library units LONGINTIO and PASCALIO are permanently assigned segment numbers 30 and 31, respectively. Segment 30 will be loaded if you use the built-in STR function or any long integer operation. Segment 31 will be loaded if you use the built-in SEEK function, or any of the following with a real argument: READ, READLN, WRITE, or WRITELN.
- If the program declares any SEGMENT procedures or functions or uses any regular units, these procedures, functions, and regular units use sequentially increasing segment numbers starting at 7.
- Each unit used by the program uses the segment number shown in the library listing. To see what these numbers are, use the LIBMAP utility as described in the Program Preparation Tools manual.

Generally, it is a good idea to use segment numbers in the range from 16 through 58, excluding those that are already used in the library.



For a complete explanation of the meaning of segment numbers, see the next chapter.

## The INTERFACE

The INTERFACE immediately follows the unit's heading. It contains declarations of constants, types, variables, procedures and functions that are public—that is, the host program can access them just as if they had been declared in the host program. The INTERFACE portion is the only part of the unit that is "visible" from the outside; it specifies how a host program can communicate with the unit.

When a procedure or function is declared in the INTERFACE, only the procedure or function heading is given. The rest of the procedure or function is declared in the IMPLEMENTATION.



No SEGMENT procedures or functions are allowed in a unit.

Include files are not allowed within the INTERFACE section.

If the unit uses another unit (as discussed further on in this chapter), a USES declaration is placed at the beginning of the INTERFACE. Thus the syntax of the INTERFACE is

### interface

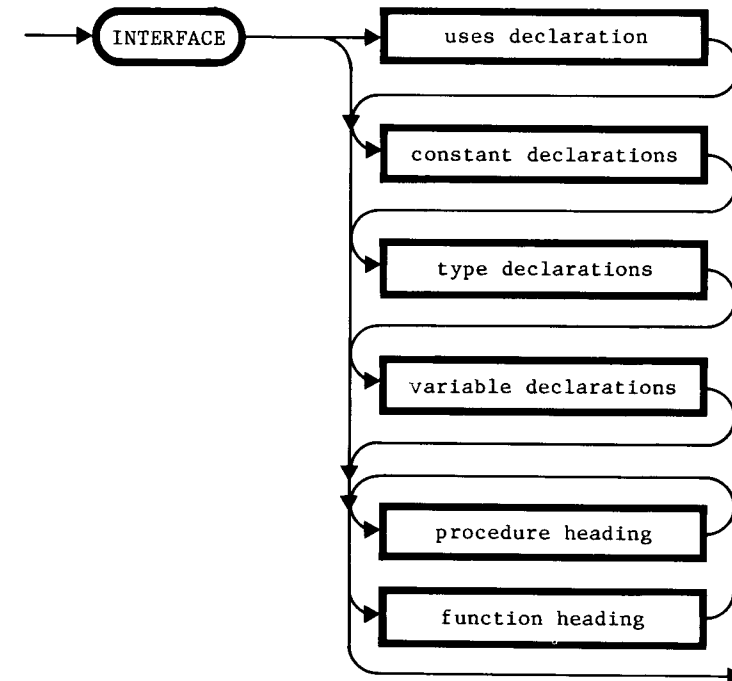

Note that no label declarations are allowed in the INTERFACE.

## The IMPLEMENTATION

The IMPLEMENTATION, if present, immediately follows the last declaration in the INTERFACE. It must be omitted if the INTERFACE does not declare any procedures or functions.

The IMPLEMENTATION begins by declaring those labels, constants, and variables that are private—that is, not accessible to the host program. Then the public procedures and functions that were

declared in the INTERFACE are defined. As shown in the example below, they are defined without parameters or function result types, since these have already been defined in the INTERFACE. Other private procedures and functions may be declared here as necessary.

The syntax of an IMPLEMENTATION is

implementation

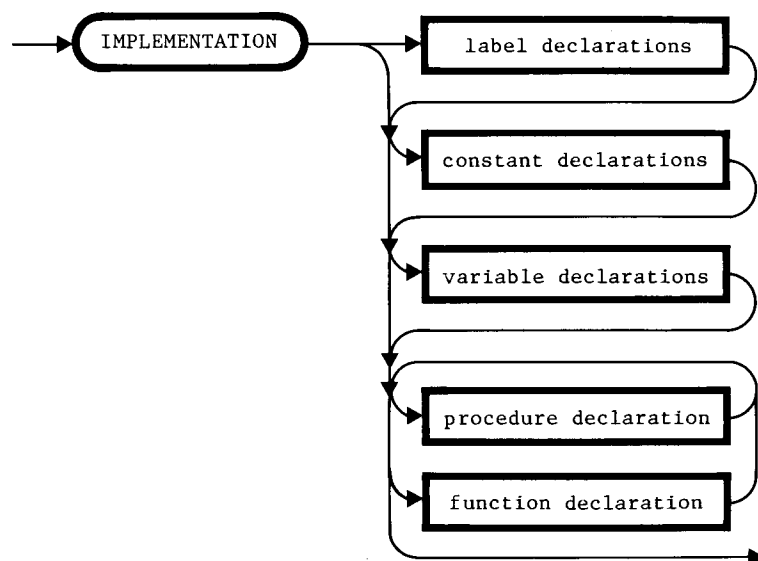

Also, no file variable may be declared anywhere in the IMPLEMENTATION, except as a VAR parameter of a procedure or function.

### The Initialization

At the end of the IMPLEMENTATION, following the last function or procedure, an "initialization" may be written. This is a compound statement followed by a period, like the body of a program. The resulting code runs automatically when the host program is executed, before the host program's own code is executed. It can be used to make any preparations that may be needed before the procedures and functions of the unit can be used. The example below shows this. If no initialization is used, the unit must still end with the word END followed by a period. The initialization code is executed exactly once.

### An Example Unit

The following is a complete intrinsic unit that has a data segment and an initialization, to demonstrate the information given above. It provides convenient features for opening textfiles.

```
UNIT OPENS;
INTRINSIC CODE 17 DATA 18;
```

```
INTERFACE
```

```
VAR OFILRESULT, NFILERESULT: INTEGFR;
{Two public variables: these are both initialized to -1,
and subsequently used by the public procedures to hold
results from the IORESULT function. Because of these
variables, the data segment is needed.}
```

Note that no USES declaration or type declarations are allowed in the IMPLEMENTATION.

```

PROCEDURE OPENOLDFILE (VAR F:TEXT; VAR PATHNAME:STRING);
PROCEDURE OPENNEWFILE (VAR F:TEXT; VAR PATHNAME:STRING);
{Two public procedures for opening text files: these are
similar except that OPENOLDFILE uses RESET while
OPENNEWFILE uses REWRITE. If the pathname has no suffix,
the suffix .TEXT is added. I/O checking is turned off
while the file is opened, and then IORESULT is used to
check whether the file was opened successfully.
OPENOLDFILE puts the result in OFILRESULT and OPENNEWFILE
puts the result in NFILRESULT; the host program can check
these variables to find out what happened.}

```

#### IMPLEMENTATION

{A private procedure that is called by the public ones, to add the .TEXT suffix to a pathname if it doesn't have a suffix:}

```

PROCEDURE ADDSUFF(VAR PATHNAME:STRING);
BEGIN
  IF POS('.TEXT', PATHNAME) = 0
  THEN PATHNAME := CONCAT(PATHNAME, '.TEXT')
END;

```

{The first of the public procedures. The parameter list is made into a comment, since the parameters have already been declared in the interface:}

```

PROCEDURE OPENOLDFILE {(VAR F:TEXT; VAR PATHNAME:STRING)};
BEGIN
  ADDSUFF(PATHNAME);
  {$IOCHECK-}
  RESET(F, PATHNAME);
  {$IOCHECK+}
  OFILRESULT := IORESULT
END;

```

{The other public procedure. Again, the parameter list is made into a comment:}

```

PROCEDURE OPENNEWFILE {(VAR F:TEXT; VAR PATHNAME:STRING)};
BEGIN
  ADDSUFF(PATHNAME);
  {$IOCHECK-}
  REWRITE(F, PATHNAME);
  {$IOCHECK+}
  NFILRESULT := IORESULT
END;

```

```

{The initialization, which provides initial values for the
two public variables. The value -1 is chosen because it is
never returned by the IORESULT function:}
BEGIN
  NFILRESULT := -1;
  OFILRESULT := -1
END.

```

## Using the Example Unit

The OPENS unit shown above can be compiled exactly as if it were a program. Then it can be installed in SYSTEM.LIBRARY, using the LIBRARY utility. Once in the library, the unit can be used by any Pascal host program. A sample program to use our unit is sketched out below:

```

PROGRAM USEIT;
USES OPENS;

VAR INFILE, OUTFILE: TEXT;
    INNAME, OUTNAME:STRING;

BEGIN
  {At this point, OFILRESULT and NFILRESULT have both been
  initialized to -1.}
  WHILE OFILRESULT <> 0 DO BEGIN
    WRITE('Type input file name: ');
    READLN(INNAME);
    OPENOLDFILE(INFILE, INNAME);

    {At this point, INNAME has had the .TEXT suffix added
    if necessary, and OFILRESULT contains the result from
    IORESULT.}

    IF OFILRESULT <> 0 THEN
      WRITELN('Can''t open file ', INNAME)
  END;

```

```

WHILE NFILERESULT <> 0 DO BEGIN
  WRITE('Type output file name: ');
  READLN(OUTNAME);
  OPENNEWFILE(OUTFILE, OUTNAME);

  {At this point, OUTNAME has had the .TEXT suffix added
  if necessary, and NFILERESULT contains the result from
  IORESULT.}

  IF NFILERESULT <> 0 THEN
    WRITELN('Can't open file ', OUTNAME)
END;
...
CLOSE(INFILE);
CLOSE(OUTFILE, LOCK)
END.

```

The USES declaration must immediately follow the heading of the host program; procedures and functions may not contain their own USES declarations. At the occurrence of a USES declaration, the Compiler references the INTERFACE of the unit as though it were part of the host text itself. Therefore all constants, types, variables, functions, and procedures publicly defined in the unit are global to the host program.



A conflict will occur if the host program declares an identifier that is also publicly declared in the unit.

## Nesting Units

A unit may also use another unit, in which case the USES declaration must appear at the beginning of the INTERFACE. However, an intrinsic unit cannot use a regular unit. For example, a unit named MUSIC might use the APPLESTUFF unit (which is an intrinsic unit):

```

UNIT MUSIC;
INTRINSIC CODE 25;

                                INTERFACE

USES APPLESTUFF;
...

```

When a host program uses a unit that uses another unit, the host program must declare that it uses the deepest nested unit first:

```

PROGRAM PLAYER;
  USES APPLESTUFF, MUSIC;

```

The following example is a unit that uses the OPENS unit shown previously.

```

UNIT OPENTXT;
INTRINSIC CODE 19 DATA 20;

                                INTERFACE

{The USES declaration must appear here;}
USES OPENS;

```

```

VAR FFF:TEXT;
{The variable FFF is a file used only by a private function;
however it has to be declared here because private files
are not allowed. This is why this unit needs a data
segment.}

```

```

PROCEDURE OPENINFILE(VAR INFILE:TEXT);
PROCEDURE OPENOUTFILE(VAR OUTFILE:TEXT);
{These are the two public procedures for opening textfiles
for input and output. They interact with the user to
obtain pathnames, and use the procedures and variables in
the OPENS unit. They allow the user to exit from the
program by pressing the RETURN key without typing a
pathname. OPENOUTFILE also checks to see if the pathname
is that of an existing file, and asks the user to confirm
that the existing file is to be destroyed.}

```

## IMPLEMENTATION

{This private function is used to find out whether a pathname is the pathname of an existing file, by opening it with OPENOLDFILE. If the file exists, it will be successfully opened and the value of OFILRESULT will be 0. The file is then closed.}

```
FUNCTION FILEXISTS(VAR NAME:STRING): BOOLEAN;
BEGIN
  OPENOLDFILE(FFF, NAME);
  FILEXISTS := OFILRESULT = 0;
  CLOSE(FFF)
END;
```

{This is the public procedure to open a textfile for input. The parameter list is made into a comment.}

```
PROCEDURE OPENINFILE{(VAR INFILE:TEXT)};
VAR INNAME: STRING;
BEGIN
  REPEAT
    WRITE('Type input filename (RETURN to quit): ');
    READLN(INNAME);
    IF LENGTH(INNAME) = 0
      THEN EXIT(PROGRAM)
    ELSE OPENOLDFILE(INFILE, INNAME);
    IF OFILRESULT <> 0
      THEN Writeln('Can''t open file ', INNAME)
    UNTIL OFILRESULT = 0
END;
```

{This is the public procedure to open a textfile for output. The parameter list is made into a comment.}

```
PROCEDURE OPENOUTFILE{(VAR OUTFILE:TEXT)};
VAR CH: CHAR;
    OUTNAME:STRING;
BEGIN
  REPEAT
    WRITE('Type output filename (RETURN to quit): ');
    READLN(OUTNAME);
    IF LENGTH(OUTNAME) = 0
      THEN EXIT(PROGRAM)
    ELSE BEGIN
      IF FILEXISTS(OUTNAME)
        THEN BEGIN
          WRITE('Destroy existing file ', OUTNAME, '? ');
          REPEAT
            READ(KEYBOARD, CH)
            UNTIL CH IN ['Y', 'y', 'N', 'n'];
            Writeln(CH);
            IF CH IN ['Y', 'y']
              THEN OPENNEWFILE(OUTFILE, OUTNAME)
            END
          ELSE OPENNEWFILE(OUTFILE, OUTNAME)
        END
      UNTIL NFILRESULT = 0
    END;
```

{This unit needs no initialization, so it ends with just the word END followed by a period.}

The following program uses the OPENINFILE and OPENOUTFILE procedures in the OPENTXT unit:

```
PROGRAM FILEUSER;
USES OPENS, OPENTXT;

VAR INFILE, OUTFILE: TEXT;

BEGIN
  OPENINPUT(INFILE);
  OPENOUTPUT(OUTFILE);
  ...
  CLOSE(INFILE);
  CLOSE(OUTFILE, LOCK)
END.
```

## **Program Libraries and SYSTEM.LIBRARY**

For any program, you can create a program library file to contain units used by that program. When the program is executed, it can then use intrinsic units from both the program library and SYSTEM.LIBRARY .

By definition, the program library for any particular program is a library file whose pathname is identical to the pathname of the program's codefile, but with the suffix .LIB instead of .CODE.

For example, suppose that /USEFUL/SORTER.CODE is the codefile's pathname. You can create a program library for this program by using the pathname /USEFUL/SORTER.LIB (note that this means it is on the same diskette).

In order to compile the program using units from the program library, you must use the Compiler's USING option; see Appendix F.

When any program is executed, each unit that it uses is searched for first in the program library, if there is one, and then in the SYSTEM.LIBRARY file on the system diskette.



If the local filename of the codefile is more than 11 characters and does not end in .CODE , then the system forms the program library name by truncating to 11 characters and adding the .LIB suffix. For example, if you have a codefile named /MINE/SYSTEM.STARTUP , the system will look for a program library named /MINE/SYSTEM.STAR.LIB .

## **Changing a Unit or its Host Program**

For test purposes, you may define a regular unit right in the host program, after the heading of the host program. In this case, you will compile both the unit and the host program together. Any subsequent changes in the unit or host program require that you recompile both.

Normally, you will define and compile a regular unit separately and use it as a library file (or store it in another library by using the LIBRARY utility). After compiling a host program that uses such a unit, you must link that unit into the host program's codefile by executing the Linker. Trying to run an unlinked code file with the R command will cause the Linker to run automatically, looking for the unit in the system library. Trying to execute an unlinked file with the X command causes the system to remind you to link the file.

Changes in the host program require that you recompile the host program. You must also link in the unit again, if it is not intrinsic.

Changes in a regular unit require you to recompile the unit, and then to recompile and relink all host programs (or other units) which use that unit.

Intrinsic units and their host programs can be changed as described above, but they do not have to be relinked.



**15**

**Program Segmentation**

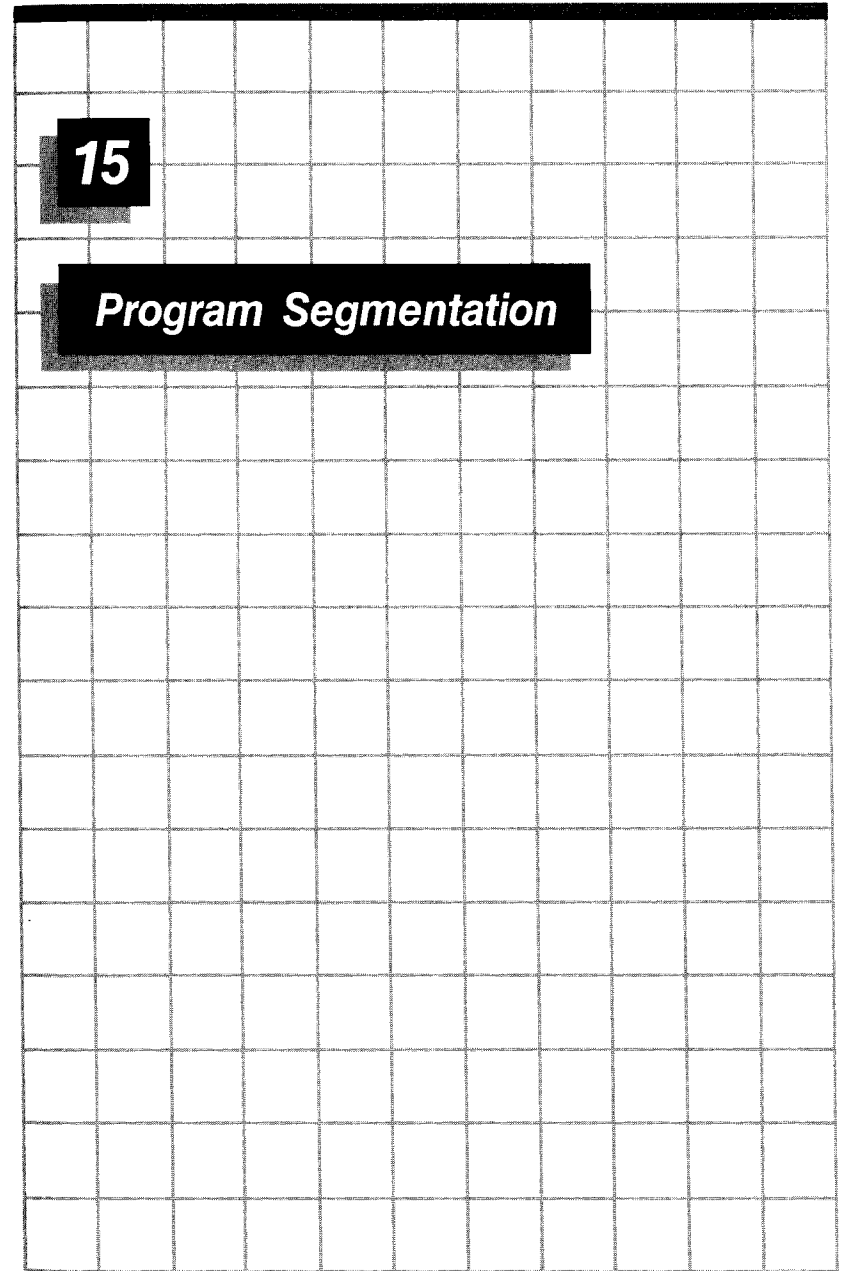

The information in this chapter is not needed for small programs, but can be crucial for large programs.

## Program Segments

To make the most efficient use of the memory space available for program code and data, programs can be divided into segments. This section gives essential information on how the Pascal System implements segmentation.

A segment is code (or data space) that can be loaded into memory by itself, independent of other segments. Every program consists of at least one segment, and some programs consist of many segments. Whenever a program is compiled, the Compiler and Linker create the following segments in the code file:

- Each SEGMENT procedure or function becomes a segment in the code file.
- Each regular unit that the program uses becomes a segment in the code file.
- The main program itself becomes a segment in the code file. This includes the program's non-SEGMENT procedures and functions.

Similarly, whenever a regular unit is compiled, the result is a code segment for the unit itself, plus an additional segment for each regular unit that is used within the unit being compiled. (Note that SEGMENT procedures and functions are not allowed inside units.)

When an intrinsic unit is compiled, it produces a code segment, and may produce a data segment as well. (Note that an intrinsic unit cannot use a regular unit.)

Note that segments do not nest—every segment is just one segment and does not contain any other segments. For example, if the declaration of a SEGMENT procedure contains the declaration of another SEGMENT procedure, the result is two distinct code segments, even though they are nested syntactically and the scope is nested.

## The Segment Dictionary

Every code file (including library files) contains information called a segment dictionary. This contains an entry for each segment in the code file; the entry has all the information the system needs to load and execute the segment.

The segment dictionary has slots for 16 entries. Therefore, one code file can contain at most 16 segments. In the case of a program, this implies one segment for the program itself, one for each SEGMENT procedure or function, and one for each regular unit used by the program.



Note that intrinsic units used by a program do not require entries in the segment dictionary of the program's code file. This is because an intrinsic unit's code segment is never in the program's code file—it is in a library file, and appears in the library file's segment dictionary.

Therefore a program can have a maximum of 16 segments, not counting segments from intrinsic units. Counting segments from intrinsic units, a program can have up to 48 segments as explained below.

## The Run-Time Segment Table

When a program is executed, the Pascal Interpreter uses a segment table which contains an entry for each segment that is used in executing the program. This table thus contains the following entries:

- Entries for 11 segments that the system uses when executing a user program
- An entry for each segment in the segment dictionary of the program's code file
- An entry for each intrinsic unit segment (both data and code segments).

The segment table has slots for up to 64 entries. Since the system uses 11, this means that 53 slots are left for the program to use. Remember that only 16 can be in the program's code file; any excess over 16 must be intrinsic unit segments. Since each intrinsic unit must be in either the program library or the SYSTEM.LIBRARY file, which are code files, there can only be 32 intrinsic units altogether. Thus the maximum number of segments a program can have is 48.

## Segment Numbers

A segment number is an index into the segment table; thus at run time, every segment has a segment number in the range 0..63 and no two segments in the program can have the same number.

These segment numbers are assigned to the program segments (except intrinsic unit segments) when the segment entries are placed in the code file's segment dictionary (before run time). Numbers are assigned as follows:

- The program itself is Segment 1.
- The segments used by the system are 0, 2..6, and 59..63. These numbers are never assigned to segments of the program.
- The segment numbers of regular unit segments and of SEGMENT procedures and functions are automatically assigned by the system; they begin at 7 and ascend. Note that after a regular unit is linked into a program, it may not have the same segment number that it had in the library.

The segment number of an intrinsic unit segment is determined by the unit's heading, when the intrinsic unit is compiled. (These numbers can be found by examining the segment dictionary of the library file with the LIBMAP utility program.)

To summarize the above, the segment numbers of the program itself, the segments used by the system, and any intrinsic units used by the program are fixed before the program is compiled; the segment numbers of regular units and of SEGMENT procedures and functions are not fixed, and are assigned as the program is compiled and linked, in ascending sequence beginning with 7.

Normally, the only time you need to specify segment numbers is in writing an intrinsic unit, as explained in Chapter 14.

## The NEXTSEG Option

When unavoidable segment-number conflicts arise there is a solution: the Compiler has a NEXTSEG option which allows you to specify the segment number of the next regular unit, SEGMENT procedure, or SEGMENT function encountered by the Compiler.

Compiler options are commands that can be embedded in a Pascal source file to control Compiler operation. Options are enclosed in comment delimiters, and the first character within the comment delimiters is the \$ character. For complete details, see Appendix F.

The NEXTSEG option has the form

```
{SNS num}
or {$NEXTSEG num}
```

where num is a literal integer constant that should be in the range 8..56. The effect is to set the next segment number to num.

The NEXTSEG option is ignored if it precedes the program heading; this means that it cannot be used to specify the segment number of the program itself.

The NEXTSEG option will only work if the specified number is greater than the "default" number that would be automatically assigned. If the number specified in the NEXTSEG option is less than or equal to the default segment number, the option is ignored.

For example, suppose that you want to use an intrinsic unit named ZEBRA, whose code segment number is 7 and whose data segment number is 8. (Normally, such numbers should be avoided in writing intrinsic units.) Your program also contains a SEGMENT procedure:

```
PROGRAM ELEPHANT;
USES ZEBRA;
...
SEGMENT PROCEDURE HORSE;
...
```

The Compiler will automatically compile the HORSE procedure as segment number 7, and when you try to execute the program, the Pascal system will not execute the codefile because the program has two different segments with the number 7. There are two remedies: recompile ZEBRA with different segment numbers (if you have the source for ZEBRA) or use the NEXTSEG option in your program:

```
PROGRAM ELEPHANT;
USES ZEBRA;
...
{$NEXTSEG 9}
SEGMENT PROCEDURE HORSE;
...
```

Now HORSE will become segment 9 instead of segment 7, and the conflict is avoided.

## Loading of Segment Procedures and Functions

Normally, the code of a SEGMENT procedure or function is present in memory only as long as it is active. If it is not active when it is called, it is loaded from the code file (on diskette). The following program illustrates this:

```
PROGRAM ONE; {Segment ONE is always in memory.}

SEGMENT PROCEDURE ALPHA; {In memory only when active.}
BEGIN
  ...
END;
```

```
SEGMENT PROCEDURE BRAVO; {In memory only when active.}
SEGMENT PROCEDURE CHARLIE; {In memory only when active.}
BEGIN {Body of CHARLIE}
  ...
  ALPHA; {When this is executed, the segments in
         memory are ONE, ALPHA, BRAVO, and CHARLIE.}
  ...
END;
BEGIN {Body of BRAVO}
  ...
  CHARLIE; {When this starts executing, the segments in
          memory are ONE, BRAVO, and CHARLIE.}
  ALPHA; {When this is executed, the segments in
         memory are ONE, BRAVO, and ALPHA.}
  ...
END;

BEGIN {Body of ONE}
  ...
  ALPHA; {When this is executed, the segments in
         memory are ONE and ALPHA.}
  BRAVO; {When this starts executing, the segments in
         memory are ONE and BRAVO.}
  ...
END.
```

The RESIDENT option can be used to alter this, as explained below.

## Loading of Unit Segments

Normally, all segments of units used by a program are loaded automatically before the program begins executing, and remain in memory throughout program execution. For example, consider the following program where DELTA and GAMMA are two units, either regular or intrinsic:

```
PROGRAM TWO
USES DELTA, GAMMA;
...
BEGIN
  ...
END.
```

Throughout program execution, the segments in memory are TWO, DELTA, and GAMMA. This can be altered by the NOLOAD option, as explained below. In any case, the initialization code for every intrinsic unit is executed at program startup time. The order in which unit names are listed in the USES statement at the beginning of the program is significant; the initialization code for the units is executed in this order.

### The NOLOAD Option

The NOLOAD option has the form

```
{N+}
or {$NOLOAD+}
```

The option is placed at the beginning of the main program body (after the BEGIN). It causes all unit segments to be swapped in and out in the same way as SEGMENT procedures: thus a unit segment is in memory only when a procedure or function in its INTERFACE is referenced by the program.

The {\$NOLOAD+} option does not prevent the initialization of a unit from being loaded and executed before program execution; but after initialization the unit segment is unloaded until it is activated. Also, the initialization code is not executed when the unit is reloaded.

Consider the following program, where HUGEPROC is a large SEGMENT procedure and BIGUNIT is a large unit. The system does not have enough memory to hold HUGEPROC and BIGUNIT at the same time, along with the program itself.

```
PROGRAM THREE;
USES BIGUNIT;

SEGMENT PROCEDURE HUGEPROC;
BEGIN
  ...
END;

BEGIN
  {$NOLOAD+} {Keeps BIGUNIT out of memory until needed.}
  HUGEPROC;
  ...
  CALCULATE; {A procedure in BIGUNIT}
  ...
  HUGEPROC
END.
```

First HUGEPROC is called; BIGUNIT is not in memory because of the {\$NOLOAD+} option. When CALCULATE is called, HUGEPROC is not in memory since it is a SEGMENT procedure; it is immediately swapped in. As soon as no part of BIGUNIT is active, it is again swapped out of memory, and HUGEPROC can be called again.

### The RESIDENT Option

The RESIDENT option has one of the following forms:

```
{R identifier}
{$RESIDENT identifier}
{R number}
{$RESIDENT number}
```

where the identifier is the name of a unit or a SEGMENT procedure or function, and the number is the segment number of a unit or a SEGMENT procedure or function. This unit, procedure, or function is then said to be "resident" within the procedure or function that contains the option.

The RESIDENT option is placed at the beginning of the body of a procedure or function (after the BEGIN). It alters the handling of segments that would otherwise be in memory only when active: that is, SEGMENT procedures and functions, and units under the NOLOAD option.

When such a segment is called from a procedure or function that specifies it to be resident, it is immediately loaded into memory and remains there as long as the calling procedure or function is active. For example, consider the following program:

```
PROGRAM FOUR;
USES BIGUNIT;

SEGMENT PROCEDURE HUGEPROC;
BEGIN
  ...
END;

PROCEDURE CALLHUGEPROC;
VAR I: INTEGER;
BEGIN
  FOR I:=1 TO 100 DO HUGEPROC
END;

PROCEDURE CALLCALCULATE;
VAR I: INTEGER;
BEGIN
  FOR I:=1 TO 100 DO CALCULATE {A procedure in BIGUNIT}
END;

BEGIN
  {$NOLOAD+} {Keeps BIGUNIT out of memory until needed.}
  HUGEPROC;
  ...
  CALCULATE;
  ...
  CALLHUGEPROC;
  ...
  CALLCALCULATE
END.
```

This resembles the previous example, but the CALLHUGEPROC and CALLCALCULATE procedures are new. As written, these two procedures have a problem: since HUGEPROC is a SEGMENT procedure, it will be swapped in from diskette 100 times when CALLHUGEPROC executes, and because of the {\$NOLOAD+} option in the main program body, BIGUNIT will be swapped in 100 times when CALLCALCULATE executes. This is obviously undesirable, and it can be prevented by using the RESIDENT option in each of these procedures:

```
PROCEDURE CALLHUGEPROC;
VAR I: INTEGER;
BEGIN
  {$RESIDENT HUGEPROC}
  FOR I:=1 TO 100 DO HUGEPROC
END;

PROCEDURE CALLCALCULATE;
VAR I: INTEGER;
BEGIN
  {$RESIDENT BIGUNIT}
  FOR I:=1 TO 100 DO CALCULATE {A procedure in BIGUNIT}
END;
```

Now HUGEPROC will be kept in memory as long as CALLHUGEPROC is active, and BIGUNIT will be kept in memory as long as CALLCALCULATE is active.

Finally, note that the RESIDENT option can be applied to more than one segment, by separating instances of the options with commas as in the following example:

```
{$RESIDENT ALPHA,RESIDENT BETA,RESIDENT GAMMA}
{no spaces after commas}
```

where ALPHA, BETA, and GAMMA are names of segments (units, SEGMENT procedures, or SEGMENT functions). The option shown would make all three segments resident in the procedure containing the option.



## **Figures and Tables**

### **Volume I—Chapters**

## **1 What is Apple III Pascal?**

---

6 Sample Program: FIRSTEXAMPLE

## **2 Overview of Pascal**

---

10 Identifier Syntax  
 12 Delimiter Characters  
 23 Arithmetic Operators  
 23 Comparison Operators  
 23 Logical Operators  
 23 Set Operators  
 30 Sample Program: FIRSTEXAMPLE

## **3 Simple Data Types**

---

36 Constant Declarations Syntax  
 38 Variable Declarations Syntax  
 39 Floating-point Number Syntax  
 40 Exponent Syntax  
 41 Non-floating-point Number Syntax  
 46 User-defined Scalar Type Syntax  
 47 Subrange Type Syntax

## 4 Expressions and Assignments

---

- 52 Assignment Statement Syntax
- 52 Variable Reference Syntax
- 54 Precedence of Operators
- 56 Arithmetic Operators
- 57 Type Results of Multiplication
- 57 Type Results of Division
- 58 Type Results of Integer Division
- 59 Type Results of Addition
- 59 Type Results of Subtraction
- 60 Relational Operators
- 62 Logical Operators with Boolean Operands
- 63 Relational Operators with Boolean Operands
- 63 Summary of Type Results
- 64 Legal Assignments for Non-structured Variables

## 5 The Flow of Control

---

- 66 Statement Syntax
- 68 Compound Statement Syntax
- 68 Procedure Call Syntax
- 69 FOR Statement Syntax
- 72 REPEAT Statement Syntax
- 72 WHILE Statement Syntax
- 74 IF Statement Syntax
- 77 CASE Statement Syntax
- 77 Caseclause Syntax
- 78 OTHERWISE Clause Syntax
- 80 EXIT Procedure Syntax
- 81 GOTO Statement Syntax

## 6 Procedures and Functions

---

- 85 Procedure Definition Syntax
- 85 Parameter List Syntax
- 86 Parameter Declaration Syntax
- 87 Block Syntax
- 91 Function Definition Syntax
- 92 Function Call Syntax
- 98 Nested Program Structure

## 7 Arrays, Sets, and Strings

---

- 105 Array Type Syntax
- 115 Set Type Syntax
- 117 Set Constructor Syntax
- 121 String Constant Syntax
- 122 STRING Type Syntax
- 125 CONCAT Function Call Syntax

## 8 Records

---

- 130 Record Type Syntax
- 130 Field List Syntax
- 133 Variant Part Syntax
- 136 WITH Statement Syntax

## 9 Pointers and Dynamic Variables

---

- 144 Pointer Type Syntax
- 147 NEW Procedure Syntax

## 10 Introduction To Files and I/O

---

- 158 File Type Syntax (For Typed File)
- 163 RESET Procedure Syntax
- 165 CLOSE Procedure Syntax
- 167 Effect of CLOSE Options (Opened with REWRITE)
- 167 Effect of CLOSE Options (Opened with RESET)
- 171 IORESULT Function Status Codes
- 177 Sample Program: RANDOMACCESS

## 11 Text I/O

---

- 186 EOLN Function Syntax
- 186 READ Procedure Call Syntax
- 190 READLN Procedure Call Syntax
- 192 WRITE Procedure Call Syntax
- 192 "Value Specifier" Syntax
- 195 WRITELN Procedure Call Syntax
- 195 Sample Program: ASCIITABLE
- 195 Sample Program: FLUSHPERIODS



---

## 12 Block File I/O and Device I/O

---

- 203 BLOCKREAD Function Call Syntax
- 204 BLOCKWRITE Function Call Syntax
- 205 Sample Program: FILECOPY
- 207 Standard Device Numbers and Names
- 208 UNITREAD and UNITWRITE Procedure Call Syntax
- 211 UNITSTATUS Procedure
- 213 UNITSTATUS Procedure: OPTION=21

## 13 Special-Purpose Built-Ins

---

- 223 Sample Procedure: UPPERCASE
- 227 IDSEARCH Declarations

## 14 Library Units

---

- 234 Regular Unit
- 235 Intrinsic Unit
- 236 Compilation Syntax
- 236 Unit Syntax
- 237 Regular Unit Heading Syntax
- 238 Intrinsic Unit Heading Syntax
- 241 INTERFACE Syntax
- 242 IMPLEMENTATION Syntax
- 243 Sample Unit: OPENS
- 245 Sample Unit: USEIT

## 15 Program Segmentation

---



---

## Volume II—Appendices

### A The TRANSCEND and REALMODES Units

- 8 Square Root, Remainder, and Transcendental Functions: Summary of Special Values and Results

### B The PGRAF Unit

- 15 Color Identifiers and Ordinalities
- 16 Color Transformations
- 18 Memory Usage
- 19 Summary of PGRAF Routines
- 20 Graphics Driver Defaults
- 28 DRAWIMAGE Parameters
- 32 Transfer Options
- 37 PGRAF INTERFACE

### C The CHAINSTUFF Unit

- 42 Sample Program Using CHAINSTUFF

### D The APPLESTUFF Unit

- 47 Sample Function: Generate Pseudo-Random Integers
- 52 SETTIME Procedure Fields

### E Floating-Point Arithmetic

- 62 Floating-Point Format
- 63 Specific Number Formats
- 65 Linear Infinities
- 66 Circular Infinities
- 67 Results of Arithmetic with Infinities
- 69 NaN Format
- 70 NaN Error Codes
- 83 Summary of Floating-Point System

---

## **F** *The Apple III Pascal Compiler*

---

- 96 Sample Compilation
- 110 Compiler Option Summary

## **G** *Special Techniques*

---

- 115 16-Bit Binary Word Structure
- 117 Sample Program: MASKER (Convert to Upper Case)
- 122 Sample Program: BINARY (Display Integer as Boolean Values)
- 123 Sample Program: REALBITS (Display Fields of Real Value)

## **H** *Comparison To Apple II Pascal*

---

## **I** *Syntax Diagrams*

---

- 134 Compilation
- 134 Program
- 135 Unit
- 135 Intrinsic Unit heading
- 135 Regular Unit heading
- 136 Interface
- 136 Implementation
- 137 Block
- 137 Uses Declarations
- 138 Label Declarations
- 138 Constant Declarations
- 138 Constant
- 138 Type Declarations
- 139 Type
- 139 Simple Type
- 139 User-defined Scalar Type
- 140 Subrange Type
- 140 Pointer Type
- 140 Set Type
- 140 String Type
- 140 Array Type
- 141 Record Type
- 141 Field List
- 141 Variant Part
- 142 File Type
- 142 Variable Declarations

- 142 Procedure Definition
- 143 Function Definition
- 143 Parameter List
- 143 Parameter Declaration
- 143 Compound Statement
- 144 Statement
- 144 Assignment Statement
- 144 Procedure Call
- 145 With Statement
- 145 Goto Statement
- 145 For Statement
- 145 Repeat Statement
- 146 While Statement
- 146 If Statement
- 146 Case Statement
- 146 Case Clause
- 147 Otherwise Clause
- 147 Expression
- 147 Simple Expression
- 148 Term
- 148 Factor
- 149 Variable reference
- 149 Function Call
- 149 Set Constructor
- 150 Unsigned Constant
- 150 Unsigned Number
- 150 Unsigned Integer
- 151 Identifier

## **J** *Tables*

---

- 154 Table 1: Execution Errors
- 155 Table 2: I/O Errors
- 157 Table 3: Reserved Words
- 158 Table 4: Predefined Identifiers
- 159 Table 5: Compiler Error Messages
- 164 Table 6: ASCII Character Codes
- 165 Table 7: Standard I/O Devices
- 166 Table 8: Size Limitations

## **K** *The TURTLEGRAPHICS Unit*

---



# Index

The page numbers in this index do not refer to every occurrence of a word or phrase in the text. Instead, they refer to the locations of significant information on the topic related to the word or phrase.

References in Volume II are shown in square brackets [ ].

## A

- ABS function 50
- actual parameter 88
- addition 58
- address [115]
- affine mode [4,65-66]
- Algol 2
- allocation of memory 132, 142, 148, 151-153, [18]
- AND operator 62, [114]
- apostrophe 11, 43, 121
- APPLE compile-time variable [106]
- Apple II formatted diskettes [91]
- Apple II Pascal [52,109, 128-131]
- Apple III Pascal 2
- Apple III Pascal System xv, [ix]
- APPLESTUFF unit [46-53]
- ARBITRARY function [48]
- arithmetic operation accuracy [71]
- arithmetic operators 22, 56-60
- array assignment 15, 110
- array comparison 110-111, 114
- array definition 104
- array element 104-105
- array of indefinite length 222-223
- array parameter 84-90, 104-105
- array representation [119-120]
- array types 15, 105-110, [140]
- array variable 104-105
- ASCII code 43-44, 219, [115, 164]
- Ascifile structure 215-216
- Ascifile type 183, 213-214
- Assembler xv, 100, [ix]
- assembly language 100
- assignment operator 52, 64
- assignment statement 18, 52, 64, [144]
- asterisk 8

ATAN function [6]  
 audio [50,53]  
 automatic line feeds 209-210  
 automatic rounding [58, 71, 78]  
 automatic type conversion 38

## B

base type of pointer 145  
 base type of set 46, 115, 117  
 BASIC 3  
 BASIC text files 183, 215  
 BCD 42  
 BEGIN 68, 72  
 biased exponent [57]  
 binary floating-point number [57]  
 binary search 225  
 binary to decimal conversion [74-75]  
 bit 111-113, 115-116, 139-140, [17,26,31,115]  
 block 26-28, 84, 87, 204, [137]  
 block file declarations 202-203  
 block file I/O 202-206  
 block structure 27, 87  
 block-structured device 157, 202-206, 214  
 BLOCKREAD function 203-204  
 BLOCKWRITE function 204-205  
 boolean logic [114]  
 BOOLEAN type 14, 45, [115]  
 boolean values [115]  
 bubbles xvii, [xi]  
 buffer variable 159, 170, 183-184, 197-200, 203  
 built-in 34, 47, [158]  
 built-in files 184, [158]  
 built-in procedures and functions 26, 47, [158]  
 buttons (on joystick) [52]  
 BW280 graphics mode [13]  
 BW560 graphics mode [13]

byte 111-113, 218-223, [26,115]  
 byte-oriented features 218-223, [124]  
 BYTESTREAM type 222-223

## C

case clause [146]  
 CASE statement 20, 76-79, [146]  
 chaining [40-43]  
 CHAINSTUFF unit [40-43]  
 CHAR type 14, 43, 182-183  
 character constants 11, 43  
 character device 156-157, 184, 209  
 character file 182, 214  
 character input 184  
 character output 194  
 character set 43  
 CHR function 44  
 clearing the screen 197  
 CLOCKINFO procedure [51]  
 CLOSE options 166-168  
 CLOSE procedure 160, 164-166  
 closure [78]  
 code segment 238, 254-255  
 code swapping 260-261  
 codefile 250, 254-255, [88]  
 COL140 graphics mode [14]  
 color table [29]  
 columns in array 106-107  
 COMMENT compiler option [98]  
 comments 8  
 comparison of sets 120  
 comparison operators 23, 60-62  
 compilation 236, [134]  
 Compile command [89]  
 compile-time error checking [92]  
 compile-time expressions [106]  
 compile-time variables [104-106]  
 Compiler 2, 79, 81, 132, 183, 254, [88-11,159]

Compiler error [92,159-163]  
 Compiler options [93-104]  
 compiling Apple II code [109]  
 compound statement 19, 67, [143]  
 CONCAT function 125  
 conditional compilation [104]  
 conditional statements 73  
 congruent type 105, 108, 138  
 conjunction 62  
 console 156-157, 180  
 CONSOLE: [165]  
 CONST 12, 35-36  
 constant [138]  
 constant declarations 12, 35-37, 39, 41-47, [138]  
 control 66-82  
 control characters 178-180  
 control variable 21, 69  
 control-C character 179-180, 187, 194, 209  
 convert overflow exception [59-60,83]  
 converting char to string 123  
 COPY function 126  
 COS function [6]  
 CP280 graphics mode [14,35]  
 CR character 178-179  
 CRUNCH 165  
 cursor 224

## D

DATA 238  
 data segment 238, 254-255  
 data types 13, 34-50  
 Datafile type 213  
 date and time [50]  
 decimal places 193  
 decimal point 38, 40, 190, 193  
 decimal to binary conversion [73-74]  
 declarations 3, 12, 35-47, [96]  
 DELETE procedure 126  
 delimiters 11

denormalized number [58, 63-64]  
 device 156, [165]  
 device driver 157, 179, 194, 206-207, 211-212  
 device driver control 210-212  
 device driver status 207-213  
 device I/O 206-213  
 difference operator 119  
 dimensions of array 105-107  
 direct recursion 92-95  
 directory 165, 207  
 disjunction 62  
 diskette block numbers 204  
 diskette file 157, 170  
 display [17]  
 display buffer [17-19]  
 DISPOSE procedure 151  
 DIV operator 57  
 dividend 57-58, [61]  
 division (integer) 57  
 division (real) 57  
 division by 0 [61]  
 divisor 57-58, [61,66,71]  
 DLE character 179, 194, 215-216  
 DLE-blank code 214-216  
 DLE-blank code conversion 209, 215-216  
 DOTAT procedure [23]  
 DOTREL procedure [24]  
 DOWNT0 69-71  
 DRAWIMAGE procedure [26]  
 dynamic variable 17, 143-150

## E

E notation 39, 193  
 Editor xv, 2, 183, 214, [ix]  
 element of array 104-106  
 ELSE 74  
 ELSEC compiler option [107]  
 empty set 117  
 END 68  
 end of file 168-169, 197-200  
 end of line 162, 179, 185-186, 197-200

end of text 179  
 ENDC compiler option [107]  
 EOF function 168-169, 180,  
 187-188, 197-200  
 EOLN function 180, 185-188,  
 197-200  
 error checking [98-100]  
 error message [92,154-155,  
 159,163]  
 ETX character 178-180  
 exception [58,59-62,77]  
 exception signal [58]  
 EXEC/ prefix [40]  
 Execute command [89]  
 execution error [96-97,154]  
 EXIT procedure 80, [41]  
 EXP function [7]  
 explicit set value 116  
 exponent 40, [57]  
 exponent field [82]  
 exponential function 50, [7]  
 expression 22, 52-55, 84,  
 87-89, [147]  
 extent of a procedure 97  
 EXTERNAL 100  
 external file 156, 158,  
 213-214  
 external function 100, [88]  
 external procedure 100, [88]

## F

factor [148]  
 FALSE 45, 62, 63  
 field identifier 130  
 field list 130, 132, [141]  
 file 156  
 file block 202-204  
 file block numbers 204  
 file buffer variable 159-161,  
 183-185, 197-200, 203  
 file component type 158  
 file declaration 159  
 FILE OF CHAR 158, 183  
 file parameter 84-90  
 file record 158-159  
 FILE type 202

file type 17, 157-159, [142]  
 file variable 157, 243  
 Filer xv, [ix]  
 fill color [15,21]  
 FILLCHAR procedure 219, [124]  
 filling [15]  
 FILLPORT procedure [24]  
 fixed-point output 193  
 floating-point arithmetic  
 [56-85]  
 floating-point number 13,  
 38-39, [57]  
 flow of control 67  
 font [33]  
 FOR statement 21, 69, [145]  
 formal parameters 88  
 formatted output 195  
 FORTRAN 4  
 FORWARD 96  
 forward definition 96  
 fraction field [58]  
 free memory 150-153  
 free union [120]  
 function 3, 25, 90-92  
 function call 25, 92, [149]  
 function complexity 101  
 function definition 91, [143]  
 function heading 236-238  
 function identifier 91  
 function size 101  
 function type 91

## G

GET and PUT with text I/O  
 185, 197-200  
 GET procedure 169-171, 203,  
 215  
 GETCVL procedure [41]  
 GLOAD procedure [34]  
 global 99  
 GOTO compiler option [100]  
 GOTO statement 22, 81, [100,  
 145]  
 GOTOXY procedure 224  
 gradual underflow [60]  
 GRAFIXMODE procedure [20]

GRAFIXON procedure [21]  
 graphics cursor [13,23]  
 graphics driver [12,25-26,  
 34-36]  
 graphics modes [13]  
 GSAVE procedure [34]

## H

HALT procedure 80, [41]  
 host program 232-233, 250-251

## I

I/O 159, 182-200, 202-203  
 I/O checking 172-174, [98,  
 156]  
 I/O devices 206-207, [165]  
 I/O error 162-164, 171-172,  
 [155]  
 I/O facilities 161-162  
 I/O units 207, [165]  
 identifier 9, 28, 37, [151]  
 IDSEARCH 226-229  
 IEEE floating-point standard  
 23, 56, [2,56-85]  
 IF statement 19, 73-75, [146]  
 IFC compiler option [107]  
 IMPLEMENTATION 241, [136]  
 IN operator 117-118  
 incarnation 94  
 INCLUDE compiler option [102]  
 include file [103]  
 index of array 104-108  
 index type 104-108  
 index values 108  
 indirect recursion 95  
 inexact result [61]  
 infinities [58]  
 infinity [58,63,68]  
 infinity arithmetic [65-67]  
 INITGRAFIX procedure [23]  
 initial value 70  
 initialization 237, 243, 260  
 input 161  
 INPUT built-in file 184

input/output conversions  
 [72-75]  
 INSERT procedure 126-127  
 INTEGER constant 41  
 INTEGER type 13, 40  
 INTERACTIVE type 158, 183,  
 216  
 INTERFACE 240-241, [136]  
 intersection operator 119-120  
 intrinsic unit 234-235,  
 238-239, 254-256, [88]  
 intrinsic unit heading [135]  
 invalid operations [61]  
 IOCHECK compiler option 172,  
 [98,156]  
 IORESULT function 171-174,  
 210, [155]

## J

Jensen and Wirth 2, [114]  
 joystick [49]

## K

K (@@)  
 keyboard [48]  
 KEYBOARD built-in file 184,  
 [158]  
 KEYPRESS function [48]

## L

label 81  
 label declarations 81, [138]  
 length attribute (LONG  
 INTEGER, STRING) 42, 124  
 LENGTH function 124  
 lexical level [96]  
 LIBMAP utility program  
 238-239, 256  
 Librarian xv, [ix]  
 library file 100, 232-251,  
 254-255, [89]  
 library unit 29, 232-251

LIBRARY utility program 233, 238  
 limit value 70  
 line-oriented input 195  
 line-oriented output 195  
 linefeed character 179, 193-194, 209-210  
 LINEREL [24]  
 LINETO [23]  
 linked list 146-147  
 Linker xv, 100, 233-234, 251, 254, [ix, 88-89]  
 list 146  
 LIST compiler option [95]  
 listing [95, 159]  
 LN function [6]  
 loading of segments 258-260  
 local 99  
 LOCK 165  
 LOG function [7]  
 logarithmic functions [7]  
 logical operators 23, 62  
 logical record 158  
 LONG INTEGER input 188-190  
 LONG INTEGER output 192  
 LONG INTEGER type 42  
 LONGINTIO unit 43, 239

## M

machine language 2  
 MARK procedure 95, 151-153  
 MAXINT 42  
 MEMAVAIL function 150-151  
 member of set 115  
 memory allocation 139-140, 142-143, 148, 151-152, [18]  
 minuend 59  
 mixed reading and writing 185, 197-200  
 MOD operator 58  
 mode parameter (device I/O) 208-210  
 modes, arithmetic [4]  
 MOVELEFT procedure 221-222, [124]

MOVEREL procedure [24]  
 MOVERIGHT procedure 221-222, [124]  
 MOVETO procedure [23]  
 multidimensional array 106-107  
 multiplication 57

## N

NaN [5, 58, 63, 69-70]  
 natural logarithm [6]  
 negation (arithmetic) 59  
 negation (boolean) 62  
 nested IF statements 75  
 nested WITH statements 137  
 nesting 97  
 nesting units 246-249  
 NEW procedure 143-144, 147-148  
 next record in file 160-161, 169, 185  
 NEXTSEG compiler option 257, [101]  
 NIL 144  
 NOLOAD compiler option 260-261, [101]  
 Non-standard devices [165]  
 NORMAL 165  
 normalized number [58, 63]  
 normalizing mode [4, 64, 79]  
 NOT operator 62, [114]  
 NOTE procedure [52]  
 NUL character 214, 216  
 null statement 67  
 numeric constants 10  
 numeric environment [79]  
 numeric functions 49  
 numeric-string input 188, 190  
 numeric-string output 191

## O

object of a pointer 145-147  
 ODD function 50, [116]

one-character string 123  
 one-dimensional array 106  
 Open Apple key 44  
 opening a file 159, 163-167  
 operand 52-64  
 operating system 159-160  
 operator 52-64  
 Options command [12]  
 OR operator 62, [114]  
 ORD function 48, [116]  
 ordinality 48, [116]  
 OTHERWISE clause 76-79, [128, 147]  
 output 161  
 OUTPUT built-in file 184  
 overflow 43, 56, [59, 60]

## P

P-code 2, [88]  
 P-machine 2, [88]  
 PACKED 113, 139  
 packed array 111-113  
 packed character array 113-114  
 packed record 139  
 packed variable 90, 111-114, 218  
 PADDLE function [52]  
 PAGE compiler option [97]  
 PAGE procedure 197  
 parameter 19, 84-90  
 parameter declaration 86, [143]  
 parameter list 68, 85, [143]  
 parentheses in expression 54  
 Pascal interpreter 2, 255, [88]  
 Pascal User Manual and Report 2  
 PASCALIO unit 176, 189, 239  
 passing arrays 109  
 pathname 157, 159, 163, 183, 213, 250, [95, 102]  
 pen color [15, 21]  
 peripheral device [165]  
 PGRAF unit [12-38]  
 physical address 144, 151-153  
 physical diskette access 170  
 plotting [14-16, 23]  
 pointer 17, 143-147, 153  
 pointer assignment 147  
 pointer comparison 144  
 pointer reference 145, 147  
 pointer type 144-145, [140]  
 pointer variable 144, 147, 152  
 POS function 124-125  
 power of ten 224  
 precedence of operators 53  
 precision of REALs [76]  
 PRED function 48  
 predecessor 48  
 predefined identifiers [158]  
 printer 156-157  
 private 241-242  
 procedure 3, 24, 84-87  
 procedure call statement 18, 68, 84-90, [144]  
 procedure complexity 101  
 procedure definition 85, [142]  
 procedure heading 85, 236-238  
 procedure identifier 68  
 procedure size 101  
 procedure termination 94-95  
 Procedure too long error [166]  
 program [134]  
 program heading 5  
 program library 250, 255, [2, 12, 40, 46, 102]  
 program listing [95]  
 program segment 254  
 program structure 5, 26, 84-101  
 projective mode [4, 65-66]  
 pseudo-random number [46-48]  
 public 232, 240  
 PURGE 165  
 PUT procedure 169-171, 203  
 PWROFTEN function 224

**Q**

QUIET compiler option [98]

**R**

railroad tracks xvii, [xi]  
 random access 175, 215  
 random numbers [46-48]  
 range checking 44, 46  
 RANGECHECK compiler option [99]  
 READ procedure 186-187, 197-200  
 READ with a char variable 187, 197-198  
 READ with a numeric variable 188, 198  
 READ with a string variable 188, 199  
 READLN procedure 190-191, 197-200, 214-215  
 real arithmetic [76]  
 real arithmetic environment [76]  
 REAL type 13, 34, 38-40  
 REALMODES unit [2,5,70,76-82]  
 record 130  
 record assignments 138  
 record comparisons 138-139  
 record field 130-131  
 record numbers 175-176  
 record parameter 84-90, 130-132  
 record type 16, 130-131, [141]  
 record variable 136  
 recursion 92-96  
 regular unit 233-234, 237, 254, [88,135]  
 relational operators 60, 63, [68]  
 RELEASE procedure 95, 151-153  
 REM function [5]  
 REMIN: [165]  
 REMOUT: [165]

REPEAT statement 20, 71, [145]  
 repetition statements 69  
 representation of arrays [119]  
 representation of REALs [76, 120]  
 representation of scalars [114]  
 reserved word 9, 226, [157]  
 RESET procedure 163-164  
 RESIDENT compiler option 261-263, [101]  
 result types 63  
 return character 169, 187, 193, 209, 214  
 REWRITE procedure 163  
 ROUND function 49, [59,78]  
 rounding [58]  
 rounding error [71]  
 rounding mode [71-72,78]  
 rows in array 106-107  
 Run command [89]  
 run-time error [97,154-156]  
 run-time error checking [97, 154-156]  
 run-time error message [97, 154-156]  
 run-time halt [97,156]  
 run-time segment table 255-256

**S**

scalar types 13, 34, 40-49  
 SCALB [62]  
 SCAN function 220-221, [124]  
 scope of built-in objects 99  
 scope of identifiers 28, 97  
 screen 224  
 screen control codes 180, 194  
 screen coordinates [13]  
 SEEK procedure 175-178  
 segment 254, [96]  
 segment dictionary 255  
 SEGMENT function 99, 239-240, 254, 258-259

segment number 238-239, 256-257, [96,154]  
 SEGMENT procedure 99-100, 239-240, 254, 258-259  
 segment table 255-256  
 semicolon 18, 67-68, 75  
 set 115  
 set comparison 120  
 set constructor 116-117, [149]  
 set difference 119  
 set equality 120  
 set inclusion 120  
 set inequality 120  
 set intersection 119  
 set member 104  
 set operations 23, 118  
 set restrictions 117  
 set types 16, 115, [140]  
 set union 118  
 set value 115  
 set variable 16, 115-117  
 SETC compiler option [107]  
 SETCHAIN procedure [40]  
 SETCTAB procedure [29]  
 SETCVAL procedure [41]  
 SETTIME procedure [50]  
 SETXCPN [59]  
 sign bit [69]  
 significand [57]  
 simple data types 34-50  
 simple expression [147]  
 simple type [139]  
 SIN function [6]  
 single quote --see "apostrophe"  
 size limitations 101, [166]  
 SIZEOF function 112, 218-219, [124]  
 SOS 156-160, 171-172  
 SOS character file 182  
 SOS device name 206-207, [165]  
 SOS-formatted diskettes 210  
 SOUND procedure [49]  
 source text 2, 8, 236, [88]  
 speaker [46]

special characters 187  
 special-purpose built-ins 218-229  
 SQR function 50  
 SORT function [5]  
 square-root function 50, [5]  
 star --see "comments"  
 statements 18, 66, [144]  
 STR procedure 127  
 string 104  
 string built-ins 124  
 string comparison 122-123  
 string constant 11, 121  
 string element 123  
 string index 123  
 string input 188  
 string length 124  
 string output 191  
 STRING type 15, 121-122, [140]  
 string value 120  
 string variable 121-123  
 strong typing [114]  
 structured data types 104, 130-140  
 subexpression 54  
 subprogram 84  
 subrange types 14, 46, [140]  
 subroutine 84  
 subscript 104  
 subtraction 59  
 subtrahend 59  
 SUCC function 48  
 successor 48  
 SWAP compiler option [94]  
 swapping of code 260-261  
 symbol table [87]  
 symbols 9  
 syntax diagrams xvii-xix, [xi-xiii,135-155]  
 system font [17]  
 SYSTEM.COMPIILER [88]  
 SYSTEM.EDITOR [89]  
 SYSTEM.LIBRARY 29, 43, 176, 194, 233, 250, 256, [2,12, 40,46,88]  
 SYSTEM.LINKER [89]

SYSTEM.PASCAL [89]  
 SYSTEM.STARTUP [43]  
 SYSTEM.SYNTAX [89,92,159]  
 SYSTEM.WRK.CODE [90]  
 SYSTEM.WRK.TEXT [88]  
 SYSTEM: [165]

## T

tag field 133, 135  
 tag identifier 133  
 tag type 133, 135  
 term [148]  
 text I/O procedures 184-185  
 text in graphics mode [17,25]  
 text mode [21]  
 TEXT type 158, 183-185, 216  
 Textfile structure 214-215  
 Textfile type 158, 183,  
 213-214  
 TEXTON procedure [21]  
 time and date [50]  
 TIME procedure 224  
 top-of-form character -- see  
 "linefeed character"  
 TRANSCEND unit 50, [2-9]  
 transcendental functions  
 [2-9]  
 transfer option [31]  
 TRESEARCH function 225-226  
 trigonometric functions 50,  
 [6]  
 TRUE 45, 62-63  
 TRUNC function 49, [59]  
 TURTLEGRAPHICS [168]  
 two's-complement [115]  
 type 34, [139]  
 type conversion functions 60  
 type declarations 13, 86, 96,  
 [138]  
 type-ahead buffer 210,  
 212-213, [48]  
 typed file 157-159, 162

## U

UCSD Pascal 2  
 unallocated memory 143,  
 150-153  
 underflow [59,60]  
 union operator 118-119  
 unit (device) name 206-207  
 unit (device) number 206-207  
 unit (in library) 232-251,  
 254, [88]  
 unit example 243-246  
 unit heading (in library unit)  
 236-238  
 unit name (I/O) [165]  
 unit number (I/O) [165]  
 unit segment loading 259-260  
 unit syntax [135]  
 UNITCLEAR procedure 210  
 UNITREAD procedure 207-210  
 UNITSTATUS procedure 211-213,  
 [125]  
 UNITWRITE procedure 207-210  
 unordered relationship 61,  
 [68]  
 UNPROTECT 165  
 unsigned constant [150]  
 unsigned integer [150]  
 unsigned number [150]  
 UNTIL 72  
 untyped file 202  
 unused memory 143, 150-153  
 USER compiler option [104]  
 user-defined font [17,33]  
 user-defined scalar types 14,  
 45-47, [115-116,139]  
 USES declaration 232-233, [3,  
 46,137]  
 USING compiler option [102]

## V

value parameters 86-88  
 VAR 89  
 variable declarations 12, 37,  
 39, 41-47, [142]

variable parameters 86, 89-90  
 variable reference 52, 89,  
 208, [149]  
 variables 37, 39, 41-47  
 variant 132-134 140, [120]  
 variant part 132-133, 140,  
 [120,141]  
 variant record 132, [120]  
 VARSTRING compiler option  
 [100]  
 viewport [16,22]

## W

Warning mode [4,64,79]  
 WHILE statement 20, 72, [146]  
 width expression 192-193  
 wildcard 156  
 window variable --see "buffer  
 variable"  
 WITH statement 22, 135-138,  
 [145]  
 word 117, 139-140, [96,119]  
 WORDSTREAM type 222-223  
 workfile [88]  
 WPROTECT 165  
 WRITE procedure 191-194, 214  
 write-protected file 165-168  
 WRITELN procedure 194-196,  
 214

## X

XLOC procedure [25]  
 XYCOLOR procedure [25]

## Y

YLOC procedure [25]

## Z

zero value [75]  
 zero-length string 123-124,  
 [41]

## Symbols

\* operator 57  
 / operator 57  
 + operator 58  
 - operator 59  
 > operator 60, 63  
 = operator 60, 63  
 < operator 60, 63  
 >= operator 60, 63  
 <= operator 60, 63  
 <> operator 60, 63  
 {\$G+} compiler option 81,  
 [100]  
 {\$I-} compiler option 172,  
 [98,156]  
 {\$I+} compiler option 172,  
 [98]  
 {\$N+} compiler option 260,  
 [101]  
 {\$NS n} compiler option 257,  
 [101]  
 {\$R identifier} compiler  
 option 261, [101]  
 {\$S+} compiler option [94]  
 {\$U filename} compiler option  
 [102]  
 .ASCII suffix 213  
 .CODE suffix [90]  
 .LIB suffix 250  
 .GRAPHIX [12]  
 .TEXT suffix 183, 213, [90]